

Single Pole (One location) or 3-Way (Multi-location)

Rotary Dimmer

120VAC, 60Hz
Cat. No. RPI06-1L, 600W (Lighted)
Cat. No. RPI06-10, 600W

INSTALLATION INSTRUCTIONS

WARNINGS:

- To be installed and/or used in accordance with appropriate electrical codes and regulations.
- If you are unsure about any part of these instructions, consult a qualified electrician.
- To avoid overheating and possible damage to this device and other equipment, do not install to control a receptacle, fluorescent lighting, a motor- or a transformer-operated appliance.
- Use only one (1) dimmer per load. The switch(es) will turn the light on at the brightness level selected at the dimmer.

CAUTIONS:

- Use with incandescent or 120V halogen fixtures only.
- Disconnect power at circuit breaker or fuse when servicing fixture.
- Use this device only with copper or copper clad wire. With aluminum wire use only devices marked CO/ALR or CU/AL.

Tools needed to install your Dimmer:

Slotted/Philips Screwdriver Electrical Tape
Pliers Pencil
Cutters Ruler

Installing Dimmer by itself or with other devices:

If installing Dimmer in a single device application, proceed with the **INSTALLING YOUR DIMMER** section. If installing Dimmer in a multi-device application, proceed as follows:

MULTI-DEVICE APPLICATION:

In multi-dimmer installations, the reduction of the dimmer's capacity is required. Refer to the chart for maximum load per dimmer.

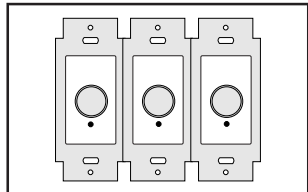

MAXIMUM LOAD PER DIMMER FOR MULTI-DEVICE			
Cat. No.	Single	Two Devices	More than 2 Devices
RPI06-1L	600W	500W	400W
RPI06-10	600W	500W	400W

INSTALLING YOUR DIMMER

NOTE: Use check boxes when Steps are completed.

Step 1 WARNING: To avoid fire, shock, or death; **TURN OFF POWER** at circuit breaker or fuse and test that power is off before wiring!

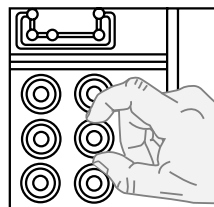
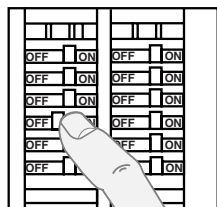

Step 2 Removing existing switch: Remove existing wallplate and switch mounting screws. Carefully pull switch from wall box. **DO NOT** remove wires attached to the switch at this time.

Step 3 Identifying your wiring application (most common):
NOTE: If the wiring in the wall box does not resemble any of these configurations, consult a qualified electrician.

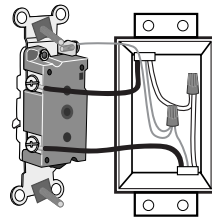

Single-Pole:

Look at the back of your switch. If there are 2 wires connected to two screw terminals (not including a green or bare copper wire used for grounding), you have a Single-Pole switch.

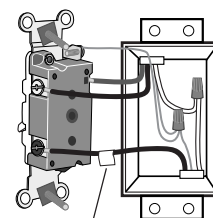

3-Way:

Look at the back of your switch. If there are 3 wires connected to three screw terminals (not including a green or bare copper wire used for grounding), you have a 3-Way switch. Note that one of the screw terminals will usually be a different color (black) or labeled Common. Tag that wire with electrical tape to identify.

Step 4 Disconnecting switch wires and preparing wires:

- Disconnect wires from screw terminals or Quickwire™ slots (shown).
- Pull off pre-cut insulation from Dimmer leads.
- Make sure that the ends of the wires from the wall box are **straight (cut if necessary)**.
- Remove 5/8" (1.6 cm) of insulation from each wire in the wall box (shown).
- For Single-Pole Application, go to Step 5A.**
- For 3-Way Application, go to Step 5B.**

Press in slot and pull out wire

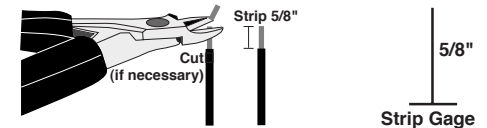

Step 5a Single-Pole Wiring Application:

This wire is used in 3-way installations only. For single pole installations, do not remove this insulating label.

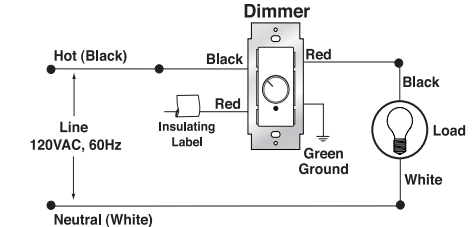
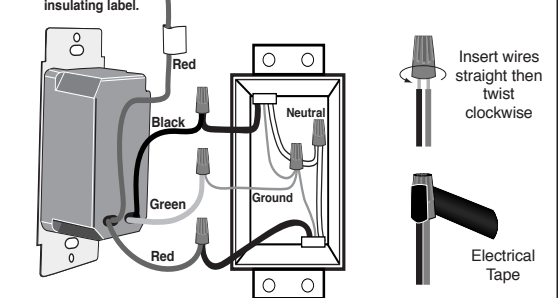

Connect wires per WIRING DIAGRAM as follows:

Screw wire nuts on clockwise making sure no bare conductors show below the wire connectors. Secure each connector with electrical tape.

- Green dimmer Ground lead to Green or bare copper wire in wall box.
- Black dimmer lead to any wall box wire removed from old switch.
- Red dimmer lead without insulating label to remaining wall box wire.
- Remaining Red dimmer lead should have Red insulation label affixed.

NOTE: If insulating label is not affixed to Red lead, use a small wire nut or electrical tape to cap off.
Proceed to Step 6.

Step 5b 3-Way Wiring Application:

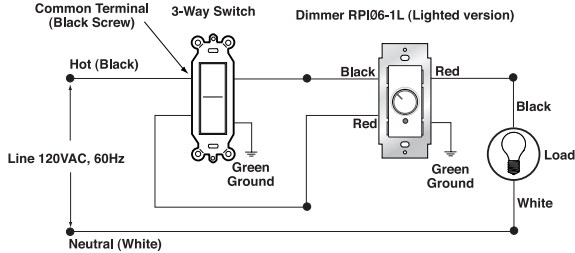
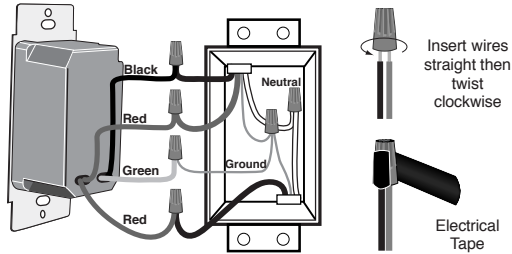

Connect wires per **WIRING DIAGRAM** as follows:

Screw wire nuts on clockwise making sure no bare conductors show below the wire connectors. Secure each connector with electrical tape.

NOTE: Control can be installed on either the Load or Line side.

- Green dimmer Ground lead to Green or bare copper wire in wall box.
- Black dimmer lead to tagged (common) wall box wire identified when removing old switch.
- Remove Red insulating label from Red lead.
- Any Red dimmer lead to any of the remaining wall box wires.
- Remaining Red dimmer lead to remaining wall box wire.

Step 7 Dimmer Mounting:

TURN OFF POWER AT CIRCUIT BREAKER OR FUSE.

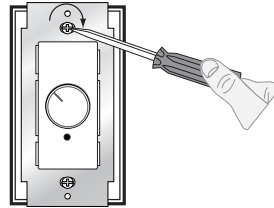

Installation may now be completed by carefully positioning all wires to provide room in wall box for dimmer. Mount dimmer into box with mounting screws supplied. Attach Decora® wallplate.

Step 8 Restore Power: Restore power at circuit breaker or fuse. Installation is complete.

OPERATION

NOTE: The indicator light will illuminate when the load is OFF to facilitate access in the dark.

NOTE: If using the dimmer in a 3-way application, the lights will turn ON at brightness set on dimmer's control knob. The lighting can be controlled from either the dimmer or the switch location.

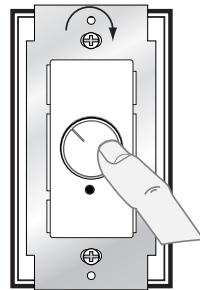

ON:

Depress push-button switch (dimmer knob) to ON position – Lights will turn ON.

OFF:

Depress push-button switch (dimmer knob) to OFF position – Lights will turn OFF.

BRIGHTEN:

Rotate control knob clockwise – Lights will BRIGHTEN to desired level.

DIM:

Rotate control knob counter-clockwise – Lights will DIM to desired level.

TROUBLESHOOTING

- Lights Flickering
 - Lamp has a bad connection.
 - Wires not secured firmly with wire connectors.
- Light does not turn ON and ON/OFF LED does not turn ON
 - Circuit breaker or fuse has tripped.
 - Lamp is burned out.
 - Lamp Neutral connection is not wired.

NOTE: If further information is needed in identifying the HOT wire in a 3-Way application, go to *Leviton's website* at www.leviton.com.

For non-standard wiring applications, refer to **Wire Nut and Connector Size Chart**

WIRE CONNECTOR / # OF COND. COMBINATION CHART

1- #12 w/ 1 to 3 #14, #16 or #18
2- #12 w/ 1 or 2 #16 or #18
1- #14 w/ 1 to 4 #16 or #18
2- #14 w/ 1 to 3 #16 or #18

PRODUCT INFORMATION

- For technical assistance, contact us at **1-800-824-3005**.
- Visit our website at www.leviton.com.

Step 6 Testing your Dimmer prior to mounting in wall box:

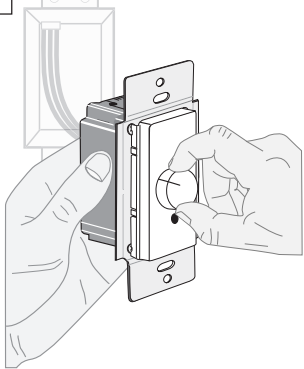

- Restore power at circuit breaker or fuse.
- Carefully holding Dimmer as shown, rotate knob fully clockwise to highest position. Lights should turn ON to brightest level. If lights do not turn ON, depress push-button switch (dimmer knob) once. Lights should turn ON to brightest level.

If lights still do not turn ON, refer to the TROUBLESHOOTING section.

LIMITED 5 YEAR WARRANTY AND EXCLUSIONS

Leviton warrants to the original consumer purchaser and not for the benefit of anyone else that this product at the time of its sale by Leviton is free of defects in materials and workmanship under normal and proper use for five years from the purchase date. Leviton's only obligation is to correct such defects by repair or replacement, at its option, if within such five year period the product is returned prepaid, with proof of purchase date, and a description of the problem to **Leviton Manufacturing Co., Inc., Att: Quality Assurance Department, 59-25 Little Neck Parkway, Little Neck, New York 11362-2591**. This warranty excludes and there is disclaimed liability for labor for removal of this product or reinstallation. This warranty is void if this product is installed improperly or in an improper environment, overloaded, misused, opened, abused, or altered in any manner, or is not used under normal operating conditions or not in accordance with any labels or instructions. There are no other or implied warranties of any kind, including merchantability and fitness for a particular purpose, but if any implied warranty is required by the applicable jurisdiction, the duration of any such implied warranty, including merchantability and fitness for a particular purpose, is limited to five years. Leviton is not liable for incidental, indirect, special, or consequential damages, including without limitation, damage to, or loss of use of, any equipment, lost sales or profits or delay or failure to perform this warranty obligation. The remedies provided herein are the exclusive remedies under this warranty, whether based on contract, tort or otherwise.

PK-93316-10-00-2B