

# Section 7

## Miniature and Molded Case Circuit Breakers

Selection Information	7-1
QO™ and QOU Miniature Circuit Breakers	7-11
Homeline™ Circuit Breakers	7-19
Multi 9™ Miniature Circuit Breakers	7-23
PowerPact™ Molded Case Circuit Breakers	7-30
Motor Circuit Protectors	7-42
Automatic Switches	7-49
500 Vdc Circuit Breakers	7-50
Mission Critical Circuit Breakers	7-52
PowerPact™ Circuit Breaker Accessories	7-54
Micrologic™ Electronic Trip Units	7-64
Masterpact™ Universal Power Circuit Breakers	7-70
Ground-Fault Protection	7-72
Dimensions and Shipping Weights	7-74
Circuit Breaker Enclosures	7-76



B-Frame



H-Frame



J-Frame



L-Frame



M-Frame



P-Frame



R-Frame

QO Miniature Circuit Breakers



QO™ Circuit Breakers



Circuit Breaker Type	Plug-on	QO			QO-H		QO-VH			QH			QOT	QO-CAFI	QO-VHCAFI	QO-DF	QOVH-DF	
	Bolt-on	QOB			QOB-H		—	—	—	QOB-VH			QHB	—	QOB-CAFI	QOB-VHCAFI	QOB-DF	QOB-VHDF
	Unit Mount	—			—	—	—	—	—	—	—	—	—	—	—	—	—	—
Number of Poles	1	2	3	2	1	2	3	1	2, 3 [1]	1, 2	3	1	1, 2	1, 2	1	1	1	
Current Range (A)	10–70	10–200 [2]	10–100	15–100	15–70	15–125	15–100	15–70	15–150	15–30	15–30	15–30	15–20	15–20	15–20	15–20		
<b>Interrupting Ratings</b>																		
UL/CSA Rating (kA) (50/60 Hz)	120 Vac	10	10	10	10	22	22	22	22	22	65	65	10	10	22	10	22	
	120/240 Vac	10	10	10	10	22	22	22	22	22	65	65	10	10	22	—	—	
	208Y/120	—	—	—	—	—	—	—	—	—	—	—	—	—	—	—	—	
	240 Vac [3]	—	—	10	10	—	—	22	—	22 [4]	—	65	—	—	—	—	—	
	277 Vac	—	—	—	—	—	—	—	—	—	—	—	—	—	—	—	—	
DC Ratings	480Y/277 Vac	—	—	—	—	—	—	—	—	—	—	—	—	—	—	—	—	
	48 Vdc	5 [5]	5 [5]	5 [5]	—	—	—	—	—	—	—	—	—	—	—	—		
	60 Vdc	—	—	—	—	—	—	—	—	—	—	—	—	—	—	—		
	65 Vdc	—	—	—	—	—	—	—	—	—	—	—	—	—	—	—		
	125 Vdc	—	—	—	—	—	—	—	—	—	—	—	—	—	—	—		
IEC 60947-2 (50/60 Hz) [6]	250 Vdc	—	—	—	—	—	—	—	—	—	—	—	—	—	—	—		
	500 Vdc	—	—	—	—	—	—	—	—	—	—	—	—	—	—	—		
<b>Special Ratings</b>																		
CCC	—	—	—	—	—	—	—	—	—	—	—	—	—	—	—	—		
Fed. Specs W-C-375B/GEN	X	—	—	—	X	—	—	—	—	X	—	X	X	—	X	X		
Other Standard	HACR [7] NOM			HACR [7]						—	—	—	HACR [7]	—	HACR [7]	HACR [7]		
<b>Accessories and Modifications</b>																		
Shunt Trip [8]	X	X	X	X	X	X	X	X	X	X [9]	X	X	X	—	—	—		
Undervoltage Trip	—	—	—	—	—	—	—	—	—	—	—	—	—	—	—			
Auxiliary Switches [8]	X	X	X	X	X	X	X	X	X	X [9]	X	X	X	—	X	—		
Alarm Switch [8]	X	X	X	X	X	X	X	X	X	X [9]	X	X	X	—	X	—		
Handle Operators	—	—	—	—	—	—	—	—	—	—	—	—	—	—	—			
Handle Padlock Attachment	X	X	X	X	X	X	X	X	X	X	X	X	X	X	X	X		
<b>Trip System Type</b>																		
Thermal-magnetic	X	X	X	X	X	X	X	X	X	X	X	X	X	X	X	X		
Molded Case Switch	X	X	X	—	—	—	—	—	—	—	—	—	—	—	—			
<b>Dimensions (1P Unit Mount)</b>																		
Dimensions (1P Unit Mount) in. (mm)	Height	3.5 (89) [1]										4.75 (121)						
	Width	—										0.75 (19) [1]						
	Depth	—										2.92 (74) [1]						
Pages	—										page 7-11							

[1] For dimensions for QOB2150VH, QOB3110VH, QOB3125VH and QOB3150VH, see page 7-74  
 [2] 2P 150–200 A requires 4P width.  
 [3] See the Supplemental Digest, Section 3 for 3Ø corner grounded systems.  
 [4] 22 kA @ 240 Vac for 3P only.  
 [5] 1P and 2P, 10–70 A and 3P 10–60 A only.  
 [6] See the Supplemental Digest Section 10 for circuit breakers with IEC ratings.  
 [7] HACR on QO, QOB 1P 10–70 A, 2P 15–100 A, 3P 10–100 A; QOB-VH 1P 15–70 A, 2P 15–125 A, 3P 15–100 A.  
 [8] Factory-installed option only.  
 [9] Factory-installed accessories are not available on QOB-VH 2P150 A and 3P 110–150 A.

**QO-GFI, QO-EPD, QOU, QOM Miniature Circuit Breakers**

		QO Circuit Breakers						QOU Circuit Breakers				QOM1 and QOM2 Main Circuit Breakers		
														
Circuit Breaker Type	Plug-on	QO-GFI			QO-VHGF1	QO-EPD QO-EPE		—				—	—	
	Bolt-on	QOB-GFI			QOB-VHGF1	QOB-EPD QOB-EPE		—				—	QOM1-VH	QOM2-VH
	Unit Mount	—	—	—	—	—	—	QOU				QYU [10]	—	
Number of Poles	1	2	3	1	1	2	3	1	2	3	1	2	—	
Current Range (A)	15–30	15–60	15–50	15–30	15–30	15–60	15–50	10–100	10–125	10–100	10–30	50–125	100–225	
Interrupting Ratings														
UL/CSA Rating (kA RMS) (50/60 Hz)	120 Vac	10	10	—	22	10	10	—	10	10	10	—	22	22
	120/240 Vac	—	10	—	—	—	10	—	10	10	10	—	22	22
	208Y/120	—	—	10	—	—	—	—	—	—	—	—	—	—
	240 Vac [11]	—	—	—	—	—	—	10	—	—	10	—	—	—
	277 Vac	—	—	—	—	—	—	—	—	—	—	5	—	—
DC Ratings	480Y/277 Vac	—	—	—	—	—	—	—	—	—	—	—	—	—
	48 Vdc	—	—	—	—	—	—	—	5 [12]	5 [12]	5 [12]	—	—	—
	60 Vdc	—	—	—	—	—	—	—	5 [13]	5 [13]	5 [13]	—	—	—
	65 Vdc	—	—	—	—	—	—	—	—	—	—	—	—	—
	125 Vdc	—	—	—	—	—	—	—	—	—	—	—	—	—
	250 Vdc	—	—	—	—	—	—	—	—	—	—	—	—	—
IEC 60947-2 (50/60 Hz) Icu	500 Vdc	—	—	—	—	—	—	—	—	—	—	—	—	—
	240 Vac	—	—	—	—	—	—	—	—	—	—	—	—	—
415 Vac	—	—	—	—	—	—	—	—	—	—	—	—	—	
Special Ratings														
CCC	—	—	—	—	—	—	—	—	X [14]	X [14]	X [14]	—	—	—
Fed. Specs W-C-375B/GEN	X	—	—	—	X	—	—	—	X	X	X	X	X	X
Other Standard	NOM			—	NOM			—	HACR [15]			—	—	—
Accessories and Modifications														
Shunt Trip	—	—	—	—	—	—	—	—	X [16]	X [16]	X [16]	X [16]	—	X [16]
Undervoltage Trip	—	—	—	—	—	—	—	—	—	—	—	—	—	—
Auxiliary Switches	X	X	X	X	X	X	X	X	X [16]	X [16]	X [16]	X [16]	—	—
Alarm Switch	X	X	X	X	X	X	X	X	X [16]	X [16]	X [16]	X [16]	—	—
Handle Operators	—	—	—	—	—	—	—	—	—	—	—	—	—	—
Handle Padlock Attachment	X	X	X	X	X	X	X	X	X	X	X	X	X	X
Trip System Type														
Thermal-magnetic	X	X	X	X	X	X	X	X	X	X	X	X	X	X
Molded Case Switch	—	—	—	—	—	—	—	—	—	X	X	—	—	—
Dimensions (1P Unit Mount)														
Dimensions (1P Unit Mount) in. (mm)	Height	4.12 (103)						4.05 (103)				5.09 (129) [17]	5.60 (142) [17]	
	Width	0.75 (19)						0.75 (19)				5.00 (127) [17]	5.07 (129) [17]	
	Depth	2.92 (74)						2.92 (74)				3.47 (88) [17]	3.60 (91) [17]	
Pages	page 7-11						page 7-17				See Section 1			

**NOTE:** All circuit breakers on this chart are UL Listed and CSA Certified unless otherwise noted.

[10] QYU is a UL 1077 supplementary protector.  
 [11] For information regarding 3Ø corner grounded systems see the Supplemental Digest, Section 3.  
 [12] 1P and 2P, 10–70 A and 3P 10–60 A only.  
 [13] QOU is UL Listed for 60 Vdc per pole 80–100 A, 1P; 80–125 A, 2P; and 70–100 A, 3P.  
 [14] 15–70 A 1P and 2P, 15–60 A 3P  
 [15] HACR on QOU 1P and 3P 15–100 A, 2P 15–125 A;  
 [16] Factory-installed option only.  
 [17] QOM1 and QOM2 dimensions are for 2-pole unit.

HOM Circuit Breakers





HOM Circuit Breakers



Circuit Breaker Type	Plug-on	HOM		HOM-CAFI	HOM-DF	HOM-GFI		HOM-EPD		HOMT
	Bolt-on	—	—	—	—	—	—	—	—	—
Unit Mount	—	—	—	—	—	—	—	—	—	—
Number of Poles		1	2	1, 2	1	1	2	1	2	1
Current Range (A)		15–50	15–200 [18]	15–20	15–20	15–20	15–50	15–20	15–50	15–50 [19]
<b>Interrupting Ratings</b>										
UL/CSA Rating (kA) (50/60 Hz)	120 Vac	10	10	10	10	10	10	10	10	10
	120/240 Vac	10	10	10	—	—	10	—	10	10
	208Y/120	—	—	—	—	—	—	—	—	—
	240 Vac [20]	—	—	—	—	—	—	—	—	—
	277 Vac	—	—	—	—	—	—	—	—	—
DC Ratings	480Y/277 Vac	—	—	—	—	—	—	—	—	—
	48 Vdc	—	—	—	—	—	—	—	—	—
	60 Vdc	—	—	—	—	—	—	—	—	—
	65 Vdc	—	—	—	—	—	—	—	—	—
	125 Vdc	—	—	—	—	—	—	—	—	—
IEC 60947-2 (50/60 Hz) [21]	250 Vdc	—	—	—	—	—	—	—	—	—
	IEC (Icu)	—	—	—	—	—	—	—	—	—
<b>Special Ratings</b>										
CCC		—	—	—	—	—	—	—	—	—
Fed. Specs W-C-375B/GEN		X	X	X	X	X	X	X	X	X
Other Standard		HACR [22] NOM			HACR [22]					
<b>Accessories and Modifications</b>										
Shunt Trip [23]		—	—	—	—	—	—	—	—	—
Undervoltage Trip		—	—	—	—	—	—	—	—	—
Auxiliary Switches [23]		—	—	—	—	—	—	—	—	—
Alarm Switch [23]		—	—	—	—	—	—	—	—	—
Handle Operators		—	—	—	—	—	—	—	—	—
Handle Padlock Attachment		X	X	X	X	—	—	—	—	X [24]
<b>Trip System Type</b>										
Thermal-magnetic		X	X	X	X	X	X	X	X	X
Molded Case Switch		—	—	—	—	—	—	—	—	—
<b>Dimensions (1P Unit Mount)</b>										
Dimensions (1P Unit Mount) in. (mm)	Height	3.13 (79)								
	Width	1.00 (25)								
	Depth	2.98 (76)								
Pages		page 1-21								

[18] 2P 150–200 A requires 4P width.  
 [19] HOMT tandem is 30 A maximum. HOMT quad tandem has 20 A maximum on outside poles, and 50 A maximum on the inside poles.  
 [20] See the Supplemental Digest, Section 3 for 3Ø corner grounded systems.  
 [21] See the Supplemental Digest Section 10 for circuit breakers with IEC ratings.  
 [22] HACR on HOM 1P 15–50 A and 2P 15–100 A.  
 [23] Factory-installed option only.  
 [24] Handle padlock attachment available for HOMT quad tandem only.

**Multi 9, EDB Miniature Circuit Breakers**

		Multi 9™ Circuit Breakers and Supplementary Protectors						EDB Circuit Breakers								
																
Circuit Breaker Type	Plug-on	—		—		—		—		EDB		EGB		EJB		
	Bolt-on	—		—		—		—		—		—		—		
Unit Mount		UL 489 C60BP			UL 1077 C60SP [25]			C60H-DC			—		—		—	
Number of Poles		1	2	3	1	2	3,4	1	2	1	2,3	1	2,3	1	2,3	
Current Range (A)		0.5–63	0.5–63	0.5–63	0.5–63	1–63	1–63	0.5–63	0.5–63	15–70	15–125	15–70	15–125	15–70	15–125	
Interrupting Ratings																
UL/CSA Rating (kA RMS) (50/60 Hz)	120 Vac	14 [26]	14 [26]	14 [26]	14 [27]	14 [27]	14 [27]	—	—	25	25	65	65	100	100	
	120/240 Vac	14 [26]	14 [26]	14 [26]	14 [27]	14 [27]	14 [27]	—	—	18	25	35	65	65	100	
	240 Vac [28]	14 [26]	14 [26]	14 [26]	14 [27]	14 [27]	14 [27]	—	—	18	25	35	65	65	100	
	277 Vac	—	—	—	10 [29]	10 [29]	10 [29]	—	—	18	18	35	35	65	65	
DC Ratings	480Y/277 Vac	10 [30]	10 [31]	10 [31]	—	10 [29]	10 [29]	—	—	—	18	—	35	—	65	
	48 Vdc	—	—	—	—	10	—	5	5	—	—	—	—	—	—	
	60 Vdc	10	10	—	20	—	—	5	5	—	—	—	—	—	—	
	65 Vdc	—	—	—	—	—	—	5	5	—	—	—	—	—	—	
	125 Vdc	—	10	—	—	—	—	5	5	—	—	—	—	—	—	
	250 Vdc	—	—	—	—	—	—	5	5	—	—	—	—	—	—	
IEC 60947-2 (50/60 Hz) Icu	500 Vdc	—	—	—	—	—	—	—	5 [32]	—	—	—	—	—	—	
	240 Vac	10	20	20	10	20	20	—	—	20	—	—	—	—	—	
415 Vac	—	10	10	—	5	5	—	—	10	—	—	—	—	—		
Special Ratings																
CCC		X	X	X	X	X	X	X	X	—	—	—	—	—	—	
Fed. Specs W-C-375B/GEN		X	X	X	—	—	—	—	—	X	X	X	X	X	X	
Other Standard		IEC						HACR								
Accessories and Modifications																
Shunt Trip		X	X	X	X	X	X	X	X	X [33]	X [33]	X [33]	X [33]	X [33]	X [33]	
Undervoltage Trip		X	X	X	X	X	X	X	X	—	—	—	—	—	—	
Auxiliary Switches		X	X	X	X	X	X	X	X	X [33]	X [33]	X [33]	X [33]	X [33]	X [33]	
Alarm Switch		X	X	X	X	X	X	X	X	X [33]	X [33]	X [33]	X [33]	X [33]	X [33]	
Handle Operators		X	X	X	X	X	X	X	X	—	—	—	—	—	—	
Handle Padlock Attachment		X	X	X	X	X	X	X	X	X	X	X	X	X	X	
Trip System Type																
Thermal-magnetic		X	X	X	X	X	X	X	X	X	X	X	X	X	X	
Molded Case Switch		—	—	—	—	—	—	—	—	—	—	—	—	—	—	
Dimensions (1P Unit Mount)																
Dimensions (1P Unit Mount) in. (mm)	Height	4.05 (103)			3.19 (81)			3.19 (81)			5.66 (144)					
	Width	0.71 (18)			0.71 (18)			0.71 (18)	1.42 (36)		0.98 (25)					
	Depth	2.76 (70)			2.76 (70)			2.56 (65)			4.05 (103)					
Pages		page 7-23						See Section 9								

**NOTE:** All circuit breakers on this chart are UL Listed and CSA Certified unless otherwise noted.

[25] C60 are recognized components per UL 1077.  
 [26] 14 kA up to 35 A, 10 kA from 40 to 63 A.  
 [27] 14 kA up to 32 A, 10 kA from 40 to 63 A.  
 [28] For information regarding 3Ø corner grounded systems see the Supplemental Digest, Section 3.  
 [29] 10 kA up to 32 A, 5 kA from 40 to 63 A.  
 [30] Up to 35 A.  
 [31] 10 kA up to 35 A.  
 [32] 2 poles must be wired in series for 500 Vdc.  
 [33] Factory-installed option only.

B-, H-, J-Frame Molded Case Circuit Breakers

	PowerPact™ 125 A B-Frame				PowerPact 150 A H-Frame					PowerPact 250 A J-Frame					
					Electronic Trip Version					Electronic Trip Version					
															
Circuit Breaker Type	BD	BG	BJ	BK	HD	HG	HJ	HL	HR	JD	JG	JJ	JL	JR	
Number of Poles	1, 2, 3, 4	1, 2, 3, 4	1, 2, 3, 4	1, 2	2, 3	2, 3	2, 3 [34]	2, 3 [34]	3	2, 3 [34]	2, 3 [34]	2, 3 [34]	2, 3 [34]	3	
Current Range (A)	15–125	15–125	15–125	15–30	15–150	15–150	15–150	15–150	15–150	70–250 [35]	70–250 [35]	70–250 [35]	70–250 [35]	70–250 [35]	
Interrupting Ratings															
UL/CSA/ NOM AC Rating (kA RMS) (50/60 Hz)	240 Vac	25	65	100	100	25	65	100	125	200	25	65	100	125	200
	480Y/277 Vac	18	35	65	65	18	35	65	100	200	18	35	65	100	200
	480 Vac	18	35	65	65	18	35	65	100	200	18	35	65	100	200
	600Y/347 Vac	14	18	25	65	14	18	25	50	100	14	18	25	50	100
UL/CSA/ NOM DC Ratings	600 Vac	—	—	—	—	14	18	25	50	100	14	18	25	50	100
	250 Vdc [36]	—	—	—	—	20	20	20	20	—	20	20	20	20	—
500 Vdc [36]	—	—	—	—	—	20	—	50	—	—	20	—	50	—	
IEC AC Rating (kA RMS) (50/60 Hz) Icu/Ics [37]	220/240 Vac	25	65	100	100	25	65	100	125	150	25	65	100	125	150
	380/415 Vac	18	35	65	65	18	35	65	100	125	18	35	65	100	125
	440/480 Vac	18	35	65	65	18	35	65	100	125	18	35	65	100	125
	500/525 Vac	14	18	25	25	14	18	25	50	75	14	20	20	20	75
IEC DC Ratings	690 Vac	—	—	—	—	—	—	—	—	20	—	—	—	—	20
	250 Vdc	—	—	—	—	—	—	—	—	20	20	20	20	—	
500 Vdc	—	—	—	—	—	—	—	—	—	20	20	20	20	—	
Special Ratings															
CCC	X	X	X	X	X	X	X	X	X	X	X	X	X	X	X
Fed. Specs W-C-375B/GEN	X	X	X	X	X	X	X	X	X	X	X	X	X	X	X
HACR	X	X	X	X	X	X	X	X	X	X	X	X	X	X	X
Connections/Terminations															
Unit Mount	X	X	X	X	X	X	X	X	X	X	X	X	X	X	X
I-Line™	X	X	X	X	X	X	X	X	X	X	X	X	X	X	X
Rear Connection	—	—	—	—	X [38]	X [38]	X	X	X	X	X	X	X	X	
Drawout	—	—	—	—	X [38]	X [38]	X	X	X	X	X	X	X	X	
Optional Lugs	X	X	X	X	X [38]	X [38]	X	X	X	X	X	X	X	X	
Accessories and Modifications															
Shunt Trip	X	X	X	X	X	X	X	X	X	X	X	X	X	X	X
Undervoltage Trip	X	X	X	X	X	X	X	X	X	X	X	X	X	X	
Auxiliary Switches	X	X	X	X	X	X	X	X	X	X	X	X	X	X	
Alarm Switch	X	X	X	X	X	X	X	X	X	X	X	X	X	X	
Motor Operator	—	—	—	—	X [38]	X [38]	X	X	X	X	X	X	X	X	
Handle Operators	X	X	X	X	X [38]	X [38]	X	X	X	X	X	X	X	X	
Mechanical Interlocks (3P)	X	X	X	—	X	X	X	X	X	X	X	X	X	X	
Handle Padlock Attachment	X	X	X	X	X [38]	X [38]	X	X	X	X	X	X	X	X	
Cylinder Lock (3P)	—	—	—	—	—	—	—	—	—	—	—	—	—	—	
Optional GF Protection	—	—	—	—	—	—	—	—	—	—	—	—	—	—	
Trip System Type															
Thermal-magnetic	X	X	X	X	X	X	X	X	X	—	X	X	X	X	X
Instantaneous-only (MCP)	—	—	—	—	—	X	X [39]	X [39]	X [39]	—	X [39]	X [39]	X	X	
Molded Case Switch (Automatic)	X	X	X	X	—	X	—	X	—	—	X	—	X	X	
Electronic	—	—	—	—	X [39]	X [39]	X [39]	X [39]	X [39]	X [39]	X [39]	X [39]	X [39]	X [39]	
Enclosures (page 7-74–page 7-76)															
General Purpose (NEMA 1)	—	—	—	—	X	X	X	X	—	X	X	X	X	—	
Raintight (NEMA 3R)	—	—	—	—	X	X	X	X	—	X	X	X	X	—	
Dust-tight (NEMA 12)	—	—	—	—	X	X	X	X	—	X	X	X	X	—	
Watertight (NEMA 4, 4X, 5)	—	—	—	—	X	X	X	X	—	X	X	X	X	—	
Explosion Proof (NEMA 7, 9)	—	—	—	—	—	—	—	—	—	X [40]	X [40]	—	—	—	
Dimensions (3P Unit Mount) in. (mm)	Height	5.4 (137)				6.4 (163)				7.5 (191)					
	Width	3.2 (81)				4.1 (104)				4.1 (104)					
	Depth	3.5 (89)				3.4 (86)				3.4 (86)					
Pages (Unit Mount)/(I-Line)	page 7-31/Section 9				page 7-32/Section 9					page 7-32/Section 9					

**NOTE:** All circuit breakers on this chart are UL Listed and CSA Certified unless otherwise noted.

[34] 2P in a 3P module.  
 [35] 70–250 A with electronic trip system  
 [36] Not available with electronic trip units  
 [37] Dual UL and IEC ratings and CE markings on circuit breakers. For additional IEC ratings, see the Supplemental Digest, Section 10.  
 [38] Not available in HD and HG 2P rating (2P module).  
 [39] 3P only.  
 [40] Not UL Listed due to wire bending space.

7 MINIATURE AND MOLDED CASE CIRCUIT BREAKERS

PowerPact™ Q-, L-Frame Molded Case Circuit Breakers

		PowerPact 250 A Q-Frame				PowerPact 600 A L-Frame				
Circuit Breaker Type		QB	QD	QG	QJ	LD	LG	LJ	LL	LR
Number of Poles		2, 3	2, 3	2, 3	2, 3	3, 4	3, 4	3, 4	3, 4	3, 4
Current Range (A)		70–250 [41]	70–250 [41]	70–250 [41]	70–250 [41]	70–600	70–600	70–600	70–600	70–600
<b>Interrupting Ratings</b>										
UL/CSA/NOM AC Rating (kA RMS) (50/60 Hz)	240 Vac	10	25	65	100	25	65	100	125	200
	480Y/277 Vac	—	—	—	—	18	35	65	100	200
	480 Vac	—	—	—	—	18	35	65	100	200
	600Y/347 Vac	—	—	—	—	14	18	25	50	100
UL/CSA/NOM DC Ratings	600 Vac	—	—	—	—	14	18	25	50	100
	250 Vdc [42]	—	—	—	—	—	—	—	—	—
IEC AC Rating (kA RMS) (50/60 Hz) Icu/Ics [44]	500 Vdc [43][42]	—	—	—	—	—	20	—	50	—
	220/240 Vac	10/5	10/5	10/5	10/5	25	65	100	125	150
	380/415 Vac	10/5	10/5	10/5	10/5	18/18	18	65	100	125
	440/480 Vac	—	—	—	—	18/18	18	65	100	125
	500/525 Vac	—	—	—	—	18/18	14	25	50	75
IEC DC Ratings	690 Vac	—	—	—	—	—	—	—	—	20
	250 Vdc	—	—	—	—	—	—	—	—	—
500 Vdc	—	—	—	—	—	—	—	—	—	—
<b>Special Ratings</b>										
CCC		—	—	—	—	X	X	X	X	X
Fed. Specs W-C-375B/GEN		X	X	X	X	X	X	X	X	X
HACR (2P, 3P)		X	X	X	—	X	X	X	X	X
<b>Connections/Terminations</b>										
Unit Mount		X	X	X	X	X	X	X	X	X
I-Line™		X	X	X	X	X	X	X	X	X
Rear Connection		—	—	—	—	X	X	X	X	X
Drawout		—	—	—	—	X	X	X	X	X
Optional Lugs		—	—	—	—	X	X	X	X	X
<b>Accessories and Modifications</b>										
Shunt Trip		—	—	—	—	X	X	X	X	X
Undervoltage Trip		—	—	—	—	X	X	X	X	X
Auxiliary Switches		—	—	—	—	X	X	X	X	X
Alarm Switch		—	—	—	—	X	X	X	X	X
Motor Operator		—	—	—	—	X	X	X	X	X
Handle Operators		—	—	—	—	X	X	X	X	X
Mechanical Interlocks (3P)		X	X	X	X	X	X	X	X	X
Handle Padlock Attachment		X	X	X	X	X	X	X	X	X
Cylinder Lock (3P[45])		—	—	—	—	—	—	—	—	—
Optional GF Protection[46]		—	—	—	—	X	X	X	X	X
<b>Trip System Type</b>										
Thermal-magnetic		X	X	X	X	—	—	—	—	—
Instantaneous-only (MCP)		—	—	—	—	—	X	X	X	X
Molded Case Switch (Automatic)		X	—	—	—	—	X	—	X	X
Electronic		—	—	—	—	X	X	X	X	X
<b>Enclosures (page 7-74–page 7-76)</b>										
General Purpose (NEMA 1)		X	X	X	X	—	—	—	—	—
Raintight (NEMA 3R)		X	X	X	X	—	—	—	—	—
Dust-tight (NEMA 12)		—	—	—	—	X [47]	X [47]	X [47]	X [47]	X [47]
Watertight (NEMA 4, 4X, 5)		—	—	—	—	—	—	—	—	—
Explosion Proof (NEMA 7, 9)		—	—	—	—	—	—	—	—	—
Dimensions (3P Unit Mount) in. (mm)	Height	6.47 (164)				13.38 (340)				
	Width	4.5 (114)				5.51 (140)				
	Depth	3.93 (100)				4.33 (110)				
Pages (Unit Mount)/(I-Line)		page 7-36/Supplemental Section 9				page 7-37/Supplemental Section 9				

**NOTE:** All circuit breakers on this chart are UL Listed and CSA Certified unless otherwise noted.

[41] I-Line Q-frame circuit breakers are available 70–225 A only. 250 A Q-frame unit-mount circuit breakers are limited to Cu conductors only.  
 [42] Not available with electronic trip units  
 [43] Ungrounded UPS systems only. See page 7-50. Special DC J-Frame only.  
 [44] Dual UL and IEC ratings and CE markings on circuit breakers. For additional IEC ratings, see the Supplemental Digest, Section 10.  
 [45] Factory-installed option only.  
 [46] Requires factory-installed "G" shunt trip and 3P module.  
 [47] Enclosure rating 1, 3R, 5 and 12.,

M-, P-, and R-Frame Molded Case Circuit Breakers

	PowerPact 800 A M-Frame			PowerPact 1200 A P-Frame				PowerPact 3000 A R-Frame				
												
Circuit Breaker Type	MG	MJ	PG	PJ	PK	PL	RG	RJ	RK	RL		
Number of Poles	2, 3	2, 3	2, 3, 4	2, 3, 4	2, 3, 4	2, 3, 4	2, 3, 4	2, 3, 4	2, 3, 4	2, 3, 4		
Current Range (A)	300–800	300–800	100–1200	100–1200	100–1200	100–1200	240–3000	240–3000	240–3000	240–3000		
<b>Interrupting Ratings</b>												
UL/CSA/NOM Rating (kA RMS) (50/60 Hz)	240 Vac	65	100	65	100	65	125	65	100	65	125	
	480Y/277 Vac	35	65	35	65	50	100	35	65	65	100	
	480 Vac	35	65	35	65	50	100	35	65	65	100	
	600Y/347 Vac	18	25	18	25	50	25	18	25	65	50	
DC Ratings	600 Vac	18	25	18	25	50	25	18	25	65	50	
	250 Vdc	—	—	—	—	—	—	—	—	—	—	
IEC (kA RMS) (50/60 Hz) Icu/Ics [49]	500 Vdc [48]	—	—	—	—	—	—	—	—	—	—	
	240 Vac	50/25	65/35	50/25	65/35	50/25	125/65	50/25	65/35	85/65	125/65	
	415 Vac	35/20	50/25	35/20	50/25	50/25	85/45	35/20	50/25	70/55	85/45	
<b>Special Ratings</b>												
CCC	X	X	X	X	X	X	X	X	X	X		
Fed. Specs W-C-375B/GEN	X	X	X	X	X	X	X	X	X	X		
HACR (2P, 3P)	X	X	X	X	X	X	X	X	X	X		
<b>Connections/Terminations</b>												
Unit Mount	X	X	X	X	X	X	X	X	X	X		
I-Line™	X	X	X	X	X	X	X [50]	X [50]	X [50]	X [50]		
Rear Connection	—	—	—	—	—	—	—	—	—	—		
Drawout	—	—	X [51]	X [51]	X [51]	X [51]	—	—	—	—		
Optional Lugs	X	X	X	X	X	X	X	X	X	X		
<b>Accessories and Modifications</b>												
Shunt Trip	X	X	X	X	X	X	X	X	X	X		
Undervoltage Trip	X	X	X	X	X	X	X	X	X	X		
Auxiliary Switches	X	X	X	X	X	X	X	X	X	X		
Alarm Switch	X	X	X	X	X	X	X	X	X	X		
Motor Operator	—	—	X [51]	X [51]	X [51]	X [51]	—	—	—	—		
Handle Operators	—	—	X [51]	X [51]	X [51]	X [51]	—	—	—	—		
Mechanical Interlocks (3P)	—	—	X	X	X	X	—	—	—	—		
Handle Padlock Attachment	X	X	X	X	X	X	X	X	X	X		
Cylinder Lock (3P)	—	—	—	—	—	—	—	—	—	—		
Optional GF Protection	—	—	X	X	X	X	X	X	X	X		
<b>Trip System Type</b>												
Thermal-magnetic	—	—	—	—	—	—	—	—	—	—		
Instantaneous-only (MCP)	—	—	—	X	X	—	—	—	—	—		
Molded Case Switch (Automatic)	—	—	X	X	X	X	X	X	X	X		
Electronic	X	X	X	X	X	X	X	X	X	X		
<b>Enclosures (page 7-74–page 7-76)</b>												
General Purpose (NEMA 1)	X	X	X	X	X	X	—	—	—	—		
Raintight (NEMA 3R)	X	X	X	X	X	X	—	—	—	—		
Dust-tight (NEMA 12)	X	X	X	X	X	X	—	—	—	—		
Watertight (NEMA 4, 4X, 5)	X	X	—	—	—	—	—	—	—	—		
Explosion Proof (NEMA 7, 9)	—	—	—	—	—	—	—	—	—	—		
Dimensions (3P Unit Mount)	Height—in. (mm)	12.80 (325)			16.20 (413)				15 (381)			
	Width—in. (mm)	8.30 (210)			8.30 (210)				16.50 (420)			
	Depth—in. (mm)	8.10 (205)			8.10 (205)				14.40 (366)			
Pages (Unit Mount)/(I-Line)	page 7-38/Section 9			page 7-39, page 7-49/Section 9				page 7-40, page 7-49/Section 9				

**NOTE:** All circuit breakers on this chart are UL Listed and CSA Certified unless otherwise noted.

[48] Ungrounded UPS systems only. See page 7-50.  
 [49] Dual UL and IEC ratings and CE markings on circuit breakers. For additional IEC ratings, see the Supplemental Digest, Section 10.  
 [50] 1000 A and 1200 A only.  
 [51] 65/50 kA Icu/Ics for 450–600 A ratings.

**Masterpact NT, NW Molded Case Circuit Breakers**



	Masterpact 1200 A					Masterpact 6000 A								
														
Circuit Breaker Type	NT-N	NT-H	NT-L1	NT-L	NT-LF [52]	NW-N	NW-H	NW-L	NW-LF [52]	NW-H	NW-L	NW-H	NW-L	
Number of Poles	3, 4	3, 4	3	3	3	3, 4	3, 4	3	3	3, 4	3	3, 4	3	
Current Range	100–1200	100–1200	100–1200	100–1200	100–1200	100–2000	100–2000	100–2000	100–2000	640–3000	640–3000	1200–6000	1200–6000	
<b>Interrupting Ratings</b>														
UL/CSA/NOM Rating (kA RMS) (50/60 Hz)	240 Vac	50	65	100	200	200	65	100	200	200	100	200	100	200
	480Y/277 Vac	50	50	65	100	100	65	100	150	150	100	150	100	150
	480 Vac	50	50	65	100	100	65	100	150	100	150	100	150	
	600Y/347 Vac	35	50	—	—	—	50	85	100	100	85	100	85	100
DC Ratings	600 Vac	35	50	—	—	—	50	85	100	100	85	100	85	100
	250 Vdc	—	—	—	—	—	—	—	—	—	—	—	—	
IEC [53] (kA RMS) Icu/ Ics	500 Vdc	—	—	—	—	—	—	—	—	—	—	—	—	
	240 Vac	—	—	—	—	—	—	—	—	—	—	—	—	
Special Ratings	415 Vac	—	—	—	—	—	—	—	—	—	—	—	—	
	CCC	—	—	—	—	—	—	—	—	—	—	—	—	
	Fed. Specs W-C-375B/GEN	—	—	—	—	—	—	—	—	—	—	—	—	
HACR (2P, 3P)	—	—	—	—	—	—	—	—	—	—	—	—	—	
<b>Connections/Terminations</b>														
Unit Mount	X	X	X	X	X	X	X	X	X	X	X	X	X	
I-Line™	—	—	—	—	—	—	—	—	—	—	—	—	—	
Rear Connection	X	X	X	X	X	X	X	X	X	X	X	X	X	
Drawout	X	X	X	X	X	X	X	X	X	X	X	X	X	
Optional Lugs	—	—	—	—	—	—	—	—	—	—	—	—	—	
<b>Accessories and Modifications</b>														
Shunt Trip	X	X	X	X	X	X	X	X	X	X	X	X	X	
Undervoltage Trip	X	X	X	X	X	X	X	X	X	X	X	X	X	
Auxiliary Switches	X	X	X	X	X	X	X	X	X	X	X	X	X	
Alarm Switch	X	X	X	X	X	X	X	X	X	X	X	X	X	
Motor Operator	X	X	X	X	X	X	X	X	X	X	X	X	X	
Handle Operators	—	—	—	—	—	—	—	—	—	—	—	—	—	
Mechanical Interlocks	X	X	X	X	X	X	X	X	X	X	X	X	X	
Padlock Attachment	X	X	X	X	X	X	X	X	X	X	X	X	X	
Cylinder Lock	—	—	—	—	—	—	—	—	—	—	—	—	—	
Optional GF Protection	X	X	X	X	X	X	X	X	X	X	X	X	X	
<b>Trip System Type</b>														
Thermal-magnetic	—	—	—	—	—	—	—	—	—	—	—	—	—	
Instantaneous-only (MCP)	—	—	—	—	—	—	—	—	—	—	—	—	—	
Molded Case Switch (Automatic)	X	X	X	X	X	X	X	X	X	X	X	X	X	
Electronic	X	X	X	X	X	X	X	X	X	X	X	X	X	
<b>Enclosures</b>														
General Purpose (NEMA 1)	—	—	—	—	—	—	—	—	—	—	—	—	—	
Raintight (NEMA 3R)	—	—	—	—	—	—	—	—	—	—	—	—	—	
Dust-tight (NEMA 12)	—	—	—	—	—	—	—	—	—	—	—	—	—	
Watertight (NEMA 4, 4X, 5)	—	—	—	—	—	—	—	—	—	—	—	—	—	
Explosion Proof (NEMA 7, 9)	—	—	—	—	—	—	—	—	—	—	—	—	—	
Dimensions (3P Unit Mount) in. (mm)	Height	12.67 (322)					17.28 (439)			17.28 (439)		17.28 (439)		
	Width	11.25 (286)					17.74 (450)			17.74 (450)		30.94 (786)		
	Depth	13.00 (331)					18.38 (467)			18.38 (467)		18.38 (467)		
Pages	page 7-70 and Catalog 0613CT0001					page 7-70 and Catalog 0613CT0001								

**NOTE:** All circuit breakers on this chart are UL Listed and CSA Certified unless otherwise noted.

[52] Tested to show arc flash hazard risk category as reference by NFPA70E.

[53] See Catalog 0613CT0001 for additional ratings and other information.

Q4 and L-Frame Molded Case Circuit Breakers

		400 A L-Frame		
				
Circuit Breaker Type		Q4	LA	LH
Number of Poles		2, 3	2, 3	2, 3
Current Range		250–400	125–400	125–400
<b>Interrupting Ratings</b>				
UL/CSA/NOM Rating (kA RMS) (50/60 Hz)	240 Vac	25	42	65
	480Y/277 Vac	—	30	35
	480 Vac	—	30	35
	600Y/347 Vac	—	22	25
DC Ratings	600 Vac	—	22	25
	250 Vdc [54]	—	10	50
	500 Vdc [55][54]	—	—	20
IEC Rating (kA RMS) Icu/Ics [56]	240 Vac	—	—	—
	415 Vac	—	20/5	20/5
IEC 50/60 Hz	For additional IEC ratings, see the Supplemental Digest Section 10.			
<b>Special Ratings</b>				
CCC		—	—	—
Fed. Specs W-C-375B/GEN		X	X	X
HACR (2P, 3P)		—	X	X
<b>Connections/Terminations</b>				
Unit Mount		X	X	X
I-Line™		X	X	X
Rear Connection		X	X	X
Drawout		—	—	—
Optional Lugs		X	X	X
<b>Accessories and Modifications</b>				
Shunt Trip		X	X	X
Undervoltage Trip		X	X	X
Auxiliary Switches		X	X	X
Alarm Switch		X	X	X
Motor Operator		X	X	X
Handle Operators		X	X	X
Mechanical Interlocks (3P)		—	X [57]	X [57]
Handle Padlock Attachment		X	X	X
Cylinder Lock (3P) [54]		X	X	X
Optional GF Protection [58]		—	—	—
<b>Trip System Type</b>				
Thermal-magnetic		X	X	X
Instantaneous-only (MCP)		—	X	X
Molded Case Switch (Automatic)		—	—	X
Electronic		—	—	—
<b>Enclosures (page 7-74–page 7-76)</b>				
General Purpose (NEMA 1)		X	X	X
Raintight (NEMA 3R)		X	X	X
Dust-tight (NEMA 12)		X	X	X
Watertight (NEMA 4, 4X, 5)		X	X	X
Explosion Proof (NEMA 7, 9)		—	—	—
Dimensions (3P Unit Mount) in. (mm)	Height	11 (279)		
	Width	6 (152)		
	Depth	5.84 (148)		
Pages (Unit Mount)/(I-Line)	Supplemental Digest Section 3 / Digest Section 9			

**NOTE:** All circuit breakers on this chart are UL Listed and CSA Certified unless otherwise noted.

[54] Factory-installed option only.  
 [55] Ungrounded UPS systems only. See page 7-50.  
 [56] Dual UL and IEC ratings and CE markings on circuit breakers. For additional IEC ratings, see the Supplemental Digest, Section 10.  
 [57] Requires circuit breaker with WB suffix.  
 [58] Requires factory-installed "G" Shunt trip and 3P module.

**QO Plug-On Circuit Breakers**

Square D brand QO miniature circuit breakers are plug-on products for use in QO load centers, NQOD and NQ panelboards, NQOD and NQ OEM interiors or Speed-D™ switchboard distribution panels. Bolt-on QOB circuit breakers are for use in NQOD and NQ panelboards or interiors. [1]

The Square D exclusive Qwik-Open™ mechanism, with a trip reaction within 1/60th of a second, is standard on all 1P 15 A and 20 A QO circuit breakers.

**Table 7.1: Plug-On Circuit Breakers**

Amperes Rating [2]	1P—120/240 Vac	2P—120/240 Vac Common Trip	2P—240 Vac [3] Common Trip	3P—240 Vac Common Trip
<b>10 k AIR</b>				
10 A	QO110	QO210	—	QO310
15 A	QO115 [4] [5]	QO215 [4]	QO215H	QO315 [4]
20 A	QO120 [4] [5]	QO220 [4]	QO220H	QO320 [4]
25 A	QO125 [4]	QO225 [4]	QO225H	QO325 [4]
30 A	QO130 [4]	QO230 [4]	QO230H	QO330 [4]
35 A	QO135 [4]	QO235 [4]	—	QO335 [4]
40 A	QO140 [4]	QO240 [4]	QO240H	QO340 [4]
45 A	QO145 [4]	QO245 [4]	—	QO345 [4]
50 A	QO150 [4]	QO250 [4]	QO250H	QO350 [4]
60 A	QO160 [4]	QO260 [4]	QO260H	QO360 [4]
70 A	QO170 [4]	QO270 [4]	QO270H	QO370 [4]
80 A	—	QO280 [4]	QO280H	QO380 [4]
90 A	—	QO290 [4]	QO290H	QO390 [4]
100 A	—	QO2100 [4]	QO2100H	QO3100 [4]
110 A	—	QO2110 [4]	—	—
125 A	—	QO2125 [4]	—	—
150 A	—	QO2150 [4] [6] [7]	—	—
175 A	—	QO2175 [4] [6] [7]	—	—
200 A	—	QO2200 [4] [6] [7]	—	—
Molded Case Switch 60 A max.—240 Vac	—	—	QO200	QO300
Molded Case Switch 100 A max.—240 Vac	—	—	QO2000 [8]	QO3000 [8]
<b>22 k AIR [4]</b>				
15 A	QO115VH [5]	QO215VH [9]	—	QO315VH [9]
20 A	QO120VH [5]	QO220VH [9]	—	QO320VH [9]
25 A	QO125VH	QO225VH [9]	—	QO325VH [9]
30 A	QO130VH	QO230VH [9]	—	QO330VH [9]
40 A	QO140VH	QO240VH [9]	—	QO340VH [9]
50 A	QO150VH	QO250VH [9]	—	QO350VH [9]
60 A	QO160VH	QO260VH [9]	—	QO360VH [9]
70 A	QO170VH	QO270VH [9]	—	QO370VH [9]
80 A	—	QO280VH [9]	—	QO380VH [9]
90 A	—	QO290VH [9]	—	QO390VH [9]
100 A	—	QO2100VH [9] [10]	—	QO3100VH [9]
110 A	—	QO2110VH [9] [10]	—	—
125 A	—	QO2125VH [9] [10]	—	—
150 A	—	QO2150VH [6] [9] [7]	—	—
175 A	—	QO2175VH [6] [9] [7]	—	—
200 A	—	QO2200VH [6] [9] [7]	—	—
<b>42 k AIR [4]</b>				
40 A	—	QOH240 [8]	—	—
45 A	—	QOH245 [8]	—	—
50 A	—	QOH250 [8]	—	—
60 A	—	QOH26 [8]	—	—
70 A	—	QOH270	—	—
80 A	—	QOH280	—	—
90 A	—	QOH290	—	—
100 A	—	QOH2100	—	—
110 A	—	QOH2110 [8]	—	—
125 A	—	QOH2125	—	—
<b>65 k AIR [4]</b>				
15 A	QH115 [5]	QH215	—	QH315 [4]
20 A	QH120 [5]	QH220	—	QH320
25 A	QH125 [8]	QH225 [8]	—	QH325 [8]
30 A	QH130	QH230	—	QH330

Refer to page 7-2 for Interrupting Ratings, Accessories, and Dimensions.



QO 1P  
1 Space Required



QO 2P  
2 Spaces Required



QO 3P  
3 Spaces Required



QO2200 2P 200 A  
4 Spaces Required

[1] See Digest Section 1 for load centers, and Section 9 for panelboards and interiors.  
 [2] 10–30 A circuit breakers are suitable for use with 60°C or 75°C conductors. 35–125 A circuit breakers are suitable for use with 75°C conductors.  
 [3] UL Listed 5 k AIR on corner grounded Delta systems.  
 [4] UL Listed as HACR type for use with air conditioning, heating and refrigeration equipment having motor group combinations and marked for use with HACR type circuit breakers.  
 [5] UL Listed as SWD (switching duty) rated. Suitable for switching 120 Vac fluorescent lighting loads.  
 [6] Requires four spaces (1 AWG–300 kcmil Al/Cu.) Suitable for switching 120 Vac fluorescent lighting loads.  
 [7] Not suitable for use in 3Ø panels. Use only in 1Ø panel rated 150 A or greater.  
 [8] Order only. Contact your local Field Office.  
 [9] UL Listed for use ahead of QO, QO-GFI, QO-EPD, QOT, QO-AFI, and QO-PL 10 k AIR circuit breakers to permit their application at 22 kA fault level.  
 [10] 100 A maximum branch mounted opposite.

### QO/QOB Ring Terminal

Table 7.2: QO/QOB Ring Terminal—Factory-installed only

Ampere Rating	Poles	Suffix
10–30 A	1, 2, 3	5237
35–60 A	1, 2	5238
35–50 A	3	
70–110 A	2	
60–100 A	3	5273

### Wire Sizes for QO/QOB Circuit Breakers

Table 7.3: Wire Sizes

Circuit Breaker Type	Ampere Rating [11]	Wire Size (AWG/kcmil)
QO 1P	10–30 A	14–8 Al/Cu
	10–30 A	(2) 14–10 Cu
	35–70 A	8–2 Al/Cu
QO 2P	10–30 A	14–8 Al/Cu
	10–30 A	(2) 14–10 Cu
	35–70 A	8–2 Al/Cu
	80–125 A	4–2/0 Al/Cu
QO 3P	150–200 A	4–300 Al/Cu
	10–30 A	14–8 Al/Cu, (2) 14–10 Cu
	35–70 A	8–2 Al/Cu
QOB-VH	80–125 A	4–2/0 Al/Cu
	110–150 A	4–300 Al/Cu
QOT	15–20 A	12–8 Al 14–8 Cu
QO-AFI, QO-GFI or QO-EPD	15–30 A	12–8 Al 14–8 Cu
	40, 50, 60 A	12–4 Al 14–6 Cu
QO-PL	10–60 A	12–2 Al 14–2 Cu

### QOT Tandem Circuit Breakers

Circuit limiting QOT tandem circuit breakers have a mounting cam as shown. Installation into a QO load center can only be made in those positions having a mounting pan rail slot. Meets Paragraph 408.54 of the NEC®. UL Listed as Class CTL



QOT 1P Tandem  
1 Space Required

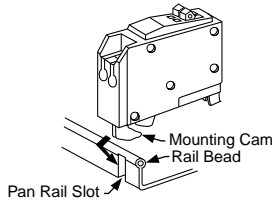

Table 7.4: QOT Tandem Circuit Breakers

Ampere Rating [12]	Cat. No. [13]
<b>1P—120/240 Vac</b>	
15 A and 15 A	QOT1515
15 A and 20 A	QOT1520
20 A and 20 A	QOT2020

**2P—120/240 Vac Common Trip**

Order two QOT1515 or QOT2020 circuit breakers and handle tie QOTHT for common switching of center two poles.

**Replacement Tandem Circuit Breakers** Includes two circuit breakers (one QO2030 and one QO3020) and handle tie QOTHT.

Table 7.5: Replacement Tandem Circuit Breakers

Ampere Rating [12]	Cat. No. [13]
<b>1P—120/240 Vac—1 Space Required</b>	
15 A and 15 A	QO1515
15 A and 20 A	QO1520
20 A and 20 A	QO2020
20 A and 30 A	QO2030
30 A and 20 A	QO3020
<b>Two 1P Individual Trip—120/240 Vac—2 Spaces Required</b>	
15 A and 15 A	Order Two QO1515 or QO2020 circuit breakers and handle tie QOTHT
15 A and 20 A	
20 A and 20 A	—
20 A and 30 A	QO20303020 [14]
30 A and 20 A	—

[11] 10–30 A circuit breakers are suitable for use with 60°C or 75°C conductors. 35–125 A circuit breakers are suitable for use with 75°C conductors.

[12] 10–30 A circuit breakers are suitable for use with 60°C or 75°C conductors. 35–125 A circuit breakers are suitable for use with 75°C conductors.

[13] UL Listed as HACR type for use with air conditioning, heating and refrigeration equipment having motor group combinations and marked for use with HACR type circuit breakers.

[14] Includes two circuit breakers (one QO2030 and one QO3020) and handle tie QOTHT.

**QO Arc-Fault Circuit Breaker**

QO arc-fault circuit breakers provide protection for Series and Parallel Type Arcing as required by the NEC and local code adoption, and comply with UL 1699.



1P  
QO-CAFI  
Plug-On Neutral



1P  
QO-CAFI  
Pigtail

**Table 7.6: QO Arc Fault Circuit Breakers (One-Pole)**

Circuit Breaker Type [15]	Ampere Rating	One-Pole 120 Vac		Two-Pole 120/240 Vac	
		10 k AIR 1 Space Required	22 k AIR 1 Space Required	10 k AIR 2 Space Required	22 k AIR 2 Space Required
Combination Arc-fault Interrupter (Pigtail Neutral)	15 20	QO115CAFI QO120CAFI	QO115VHCAFI QO120VHCAFI	QO215CAFI [16] QO220CAFI [16]	QO215VHCAFI [16] QO220VHCAFI [16]
Plug-On Neutral Combination Arc-fault Interrupter	15 20	QO115PCAFI QO120PCAFI	QO115VHPCAFI QO120VHPCAFI		

**QO-Dual Function Circuit Breaker**

QO Combination Arc Fault and Ground Fault Circuit Interrupters (Dual Function) provide overload and short circuit protection, plus arc fault and ground fault protection in accordance with the NEC, UL 1699 and UL943.



1P QO-DF  
Plug-on Neutral



1P QO-DF  
Pigtail

**Table 7.7: QO-Dual Function Arc Fault Circuit Breakers**

Circuit Breaker Type [17]	Ampere Rating	1P 120 Vac 10 k AIR 1 Space Required	1P 120 Vac 22 k AIR 1 Space Required
Combination Arc-fault and Ground Fault Circuit Interrupter (Pigtail Neutral)	15 20	QO115DF QO120DF	QO115VHDF QO120VHDF
Plug-On Neutral Combination Arc-fault and Ground Fault Circuit Interrupter	15 20	QO115PDF QO120PDF	QO115VHPDF QO120VHPDF

**QO-GFI**

Qwik-Gard™ circuit breakers provide overload and short circuit protection, combined with Class A ground fault protection. Class A denotes a ground fault circuit interrupter that will trip when a fault current to ground is 6 mA or more, for people protection. Do not connect to more than 250 feet of load conductor for the total one-way run to prevent nuisance tripping.



1P  
QO-GFI



2P  
QO-GFI

**Table 7.8: QO-GFI Circuit Breakers**

Ampere Rating [18]	Qwik-Gard Circuit Breakers With Ground Fault Circuit Interrupter			
	1P 120 Vac		2P Common Trip 120/240 Vac	3P Common Trip 208Y/120 Vac
	10 k AIR 1 Space Required	22 k AIR 1 Space Required	10 k AIR 2 Spaces Required	10 k AIR 3 Spaces Required
15	QO115GFI	QO115VHGFI	QO215GFI	QO315GFI
20	QO120GFI	QO120VHGFI	QO220GFI	QO320GFI
25	QO125GFI	QO125VHGFI	QO225GFI	—
30	QO130GFI	QO130VHGFI	QO230GFI	QO330GFI
40	—	—	QO240GFI	QO340GFI
50	—	—	QO250GFI	QO350GFI
60	—	—	QO260GFI [19]	—

**QO-EPD/EPE**

QO-EPD/EPE circuit breakers provide overload and short circuit protection combined with Class B ground fault protection. They are designed to provide ground fault protection of equipment at a 30 mA level (EPD) or 100 mA level (EPE). They are not designed to protect people from electrical shock.



QO 1P  
With Shunt Trip

**Table 7.9: QO-EPD Circuit Breakers**

Ampere Rating [20]	1P 120 Vac 10 k AIR 1 Space Required	2P Common Trip 120/240 Vac 10 k AIR 2 Spaces Required	3P Common Trip 240 Vac 10 k AIR 3 Spaces Required	
15	QO115EPD	QO215EPD	QO315EPD [21]	QO315EPE [21]
20	QO120EPD	QO220EPD	QO320EPD [21]	QO320EPE [21]
25	QO125EPD	QO225EPD	—	—
30	QO130EPD	QO230EPD	QO330EPD [21]	QO330EPE [21]
40	—	QO240EPD	QO340EPD [21]	QO340EPE [21]
50	—	QO250EPD	QO350EPD [21]	QO350EPE [21]
60	—	QO260EPD [22]	—	—

[15] UL Listed as HACR type for use with air conditioning, heating and refrigeration equipment having motor group combinations and marked for use with HACR type circuit breakers.  
 [16] For 120/240 V only, not for 208Y/120 V.  
 [17] UL Listed as HACR type for use with air conditioning, heating and refrigeration equipment having motor group combinations and marked for use with HACR type circuit breakers.  
 [18] 10–30 A circuit breakers are suitable for use with 60°C or 75°C conductors. 35–60 A circuit breakers are suitable for use with 75°C conductors.  
 [19] Suitable only for feeding 240 Vac and 208 Vac two-wire loads. Does not contain load neutral connection.  
 [20] 10–30 A circuit breakers are suitable for use with 60°C or 75°C conductors. 35–60 A circuit breakers are suitable for use with 75°C conductors.  
 [21] See note in Instruction Bulletin when using in an enclosure with a QO403 or QON prefix.  
 [22] Suitable only for feeding 240 Vac and 208 Vac two-wire loads. Does not contain load neutral connection.

**QO-SWN**

Switch Neutral Common Trip 2008 NEC® 514.11



Two-wire QO-SWN



Three-wire QO-SWN

**Table 7.10: QO-SWN Circuit Breakers**

Ampere Rating [23]	2 Wire 120 Vac 10 k AIR 2 Spaces Required	3 Wire 120/240 Vac 10 k AIR 3 Spaces Required
10	QO210SWN	QO310SWN
15	QO215SWN	QO315SWN
20	QO220SWN	QO320SWN
25	QO225SWN	QO325SWN
30	QO230SWN	QO330SWN
40	QO240SWN	QO340SWN
50	QO250SWN	QO350SWN

**QO-HID**

HID circuit breakers are for use on circuits feeding fluorescent and high intensity discharge (HID) lighting systems such as mercury vapor, metal halide, or high pressure sodium. These circuit breakers are physically interchangeable with QO circuit breakers.

**Table 7.11: QO-HID Circuit Breakers**

Ampere Rating [23]	1P 120/240 Vac 10 k AIR 1 Space Required	2P Common Trip 120/240 Vac 10 k AIR 2 Spaces Required	3P Common Trip 240 Vac 10 k AIR 3 Spaces Required
15	QO115HID [24]	QO215HID	QO315HID
20		QO220HID	QO320HID
25	QO125HID	QO225HID	QO325HID
30	QO130HID	QO230HID	QO330HID
40	QO140HID	QO240HID	—
50	QO150HID	QO250HID	—

**QO-K**

Key operated QO circuit breakers are available in single-pole construction and can be mounted in any single-pole space which will accept a standard QO. These circuit breakers can be turned ON or OFF or to RESET with a special key (catalog number QOK10) included with the circuit breaker. These circuit breakers are UL Listed and available as shown in the table.



QO-K Key Operated

**Table 7.12: QO-K Circuit Breakers**

120 Vac—10 k AIR (1 Space Required)			
Ampere Rating [23]	Cat. No.	Ampere Rating [23]	Cat. No.
10	QO110K	25	QO125K
15	QO115K	30	QO130K
20	QO120K		

**QO-HM**

High magnetic trip circuit breakers are recommended for applications where high initial inrush may occur and for individual dimmer applications.

**Table 7.13: QO-HM Circuit Breakers**

120 Vac—10 k AIR	
Ampere Rating [23]	1P
15 A	QO115HM [25] [26]
20 A	QO120HM [25] [26]

**Non-Automatic (Standard) Miniature Switches**

Miniature non-automatic switches have the same physical packaging as miniature circuit breakers, but open only when the handle is switched to the OFF position.

Non-automatic switches provide no overcurrent protection or short circuit protection. They must not be used on systems that have an available fault current greater than the values listed in the table. Non-automatic switches are UL Listed per UL 1087 and are CSA certified.

**Table 7.14: QO Non-Automatic Miniature Switches, 240 Vac 10 kA**

Ampere Rating	2P	3P
60	QO200	QO300
100	QO2000	QO3000

[23] 10–30 A circuit breakers are suitable for use with 60oC or 75oC conductors. 35–60 A circuit breakers are suitable for use with 75oC conductors.

[24] UL Listed as SWD (switching duty) rated. Suitable for switching 120 Vac fluorescent lighting loads.

[25] UL Listed as HACR type for use with air conditioning, heating and refrigeration equipment haing motor group combinations and marked for use with HACR type circuit breakers.

[26] UL Listed as SWD (switching duty) rated. Suitable for switching 120 Vac fluorescent lighting loads.

**Accessories for QO/QOB Circuit Breakers**

**Table 7.15: Accessories for use with QO and QOB Miniature Circuit Breakers**

Description	Cat. No.	Schedule	
<b>Handle Attachments</b>			
Handle Tie	QO1HT QO1HT	DE2E DE2E	
Handle Clamp	QO1LO HLO1	DE2E DE2E	
Handle Padlock Attachment for Padlocking in ON or OFF position	For padlocking 1P QO circuit breaker in ON or OFF position Loose attachment Fixed attachment	QOHPL QO1PA	DE2E DE2E
	For padlocking 1P side-by-side QOT circuit breaker in ON or OFF position	QOTHPA	DE2E
	For padlocking 2P QO-GFI circuit breakers in either ON or OFF position, fixed attachment.	GF12PA	DE2A
Handle Padlock Attachment for Padlocking in OFF position	For 2P and 3P QO and Q1 standard circuit breakers which require padlocking in either ON or OFF position. Loose attachment Fixed attachment	QO1HPL QO1PL	DE2E DE2E
	For padlocking 1P QO circuit breaker in OFF position only, fixed attachment.	QO1PAF	DE2E
	For padlocking 2P and 3P QO circuit breakers in OFF position only, fixed attachment.	QO2PAF	DE2E
Ring Terminal	For padlocking 1P QO-GFI, QO-CAFI, QO-DF and QO-EPD circuit breakers in OFF position only, fixed attachment.	QOGF1PAF	DE2E
	For padlocking 2P QO-GFI, QO-CAFI and QO-EPD circuit breakers in OFF position only, fixed attachment.	QOGF2PAF	DE2E
	Ring terminals are available as a factory-installed option.	See page 7-10	DE2A
Sub-feed Lugs	QO60SL QO2125SL QO2225SL [27] QO3125SL	DE2A DE2A DE2A DE3	
Mechanical Interlock Attachment	QO2DTI	DE2E	
With Retaining Kit	QO2DTIM	DE2E	

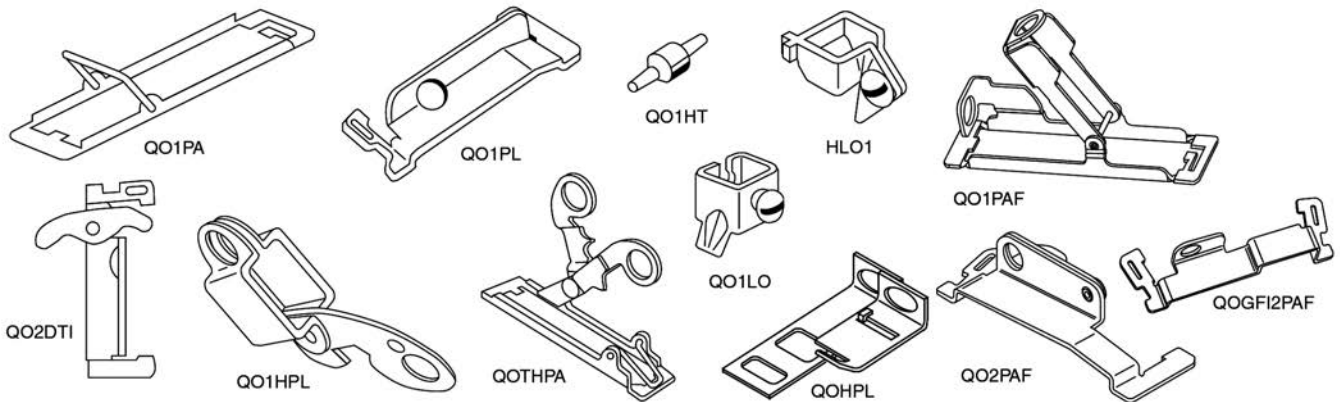

**Factory-Installed Accessories for use with QO and QOB Miniature Circuit Breakers**

Factory-installed electrical accessories take up an additional pole space on QO, QO-GFI, QO-EPD, QO-SWN and QOU circuit breakers. All AC electrical accessories shown below are rated for 50/60 Hz. Accessories are not available for QOB-VH (2P 150 A and 3P 110-150 A) circuit breakers or QO, QOU molded case switches. QO circuit breakers will accept only one accessory per circuit breaker. Undervoltage trip is not available on miniature circuit breakers. Factory-installed accessories are not available for QO-AFI or QO-CAFI Arc Fault Circuit Breakers or on QO2150, QO2175, or QO2200 circuit breakers.

**Table 7.16: Factory-Installed Accessories**

Accessory	Description	Rated Voltage	Coil Burden	Cat. No. Suffix	Accessory	Description	Contact Comb.	Max. Voltage	Max.	Cat. No. Suffix
Shunt Trip	Trips the circuit breaker from a remote location by means of a trip coil energized from a separate circuit. A 120 Vac shunt trip will operate at 55% or more of rated voltage. All other shunt trips will operate at 75% or more of rated voltage. <b>Application</b> <ul style="list-style-type: none"> <li>For use with momentary or maintained push button.</li> <li>Not available on QO-GFI, QO-EPD.</li> <li>Shunt trip terminals accept (2) 0.14-0.12 AWG Cu.</li> </ul>	12 Vac/Vdc 24 Vac/Vdc	60 VA 168 VA	-1042	Auxiliary Switches	Monitors circuit breaker contact status and provides a remote signal indicating the circuit breaker contacts are OPEN or CLOSED. <b>Application</b> <ul style="list-style-type: none"> <li>Auxiliary switch terminals accept (2) 14-12 AWG Cu leads.</li> <li>Leads (EH): Yellow for "A", Blue for "B", Striped common 18 AWG Cu.</li> </ul>	1A 1B	120 Vac 120 Vac	5 A 5 A	-1200 -1201
		120 Vac 208 Vac 240 Vac	72 VA 228 VA 288 VA	-1021	Alarm Switches	Used with control circuits and is actuated only when the circuit breaker has tripped. Standard construction includes a normally-open contact. <b>Application</b> <ul style="list-style-type: none"> <li>Leads: Alarm switch terminals accept (2) 14-12 AWG Cu leads.</li> </ul>	1A	120 Vac	5 A	-2100

[27] Not suitable for use in 3Ø panels. Use only in 1Ø panel rated 150 A or greater.

QO Mounting Bases

Table 7.17: QO OEM Mounting Bases—UL Recognized Components

Voltage System	Main Lug Rating	1P Spaces	Max. No. 1P	Mounting Bases Cat. No.	Main Wire Size AWG/kcmil
<b>QO Plug-On Mounting Bases—For unit mounting QO, QO-GFI, QO-AFI and QO-EPD circuit breakers</b>					
1Ø2W 240 Vac Max. 10 k AIC (Without Neutral Assembly)	70 A	2	2	QON2L70	14–4 Cu, 12–3 Al
	125 A	4	4	SK9948BW	12–1/0 Cu/Al
	125 A	4	4	SK9842	12–1/0 Cu/Al
	125 A	6	6	SK9795	12–1/0 Cu/Al
	125 A	6	6	SK9801	12–1/0 Cu/Al
	150 A	6	6	SK9796BW	8–3/0 Cu/Al
1Ø3W 240 Vac Max. 10 k AIC	150 A	8	8	SK9797	8–3/0 Cu/Al
	40 A	2	2	QON2L40	14–6 Cu, 12–6 Al
	70 A	2	4	QON24L70	14–4 Cu, 12–3 Al
	100 A	6	12	QON612L100	8–1/0 Cu/Al
	100 A	8	16	QON816L100	8–1/0 Cu/Al
	100 A	12	12	QON12L100	12–2/0 Cu/Al
	100 A	12	12	QON12L100SF [28]	6–2/0 Cu/Al
	125 A	12	12	QON112L125I	4–2/0 Cu/Al
	125 A	12	24	QON11224L125I	4–2/0 Cu/Al
	125 A	16	16	QON116L125I	4–2/0 Cu/Al
	125 A	16	24	QON11624L125I	4–2/0 Cu/Al
	125 A	20	20	QON120L125I	4–2/0 Cu/Al
	125 A	24	24	QON124L125I	6–2/0 Cu/Al
	125 A	32	32	QON132L125I	4–2/0 Cu/Al
	125 A	20	24	QON12024L125I	4–2/0 Cu/Al
	150 A	24	24	QON124L150I	4–250 Cu/Al
	200 A	12	12	QON124L200I	4–250 Cu/Al
	200 A	12	12	QON12L200FTL [28]	4–250 Cu/Al
	200 A	24	24	QON124L200I	4–250 Cu/Al
	200 A	24	24	QON124L200DL [28]	(2) 4–300 Cu/Al
3Ø3W 240 Vac Max. 10 k AIC (Without Neutral Assy.)	200 A	30	30	QON130L200I	4–250 Cu/Al
	225 A	42	42	QON142L225I	4–300 Cu/Al
	125 A	12	12	QON312L125	4–2/0 Cu/Al
	125 A	20	20	QON320L125	4–2/0 Cu/Al
	125 A	24	24	QON324L125	4–2/0 Cu/Al
	200 A	18	18	QON318L200	4–300 Cu/Al
	200 A	24	24	QON324L200	4–300 Cu/Al
	200 A	30	30	QON330L200	4–300 Cu/Al
	225 A	42	42	QON342L225	4–300 Cu/Al
	3Ø4W 240 Vac Max. 10 k AIC	60 A	3	3	QON403L60N
125 A		12	12	QON312L125I	4–2/0 Cu/Al
125 A		20	20	QON320L125I [29]	4–2/0 Cu/Al
125 A		24	24	QON324L125I	4–2/0 Cu/Al
200 A		18	18	QON318L200I	4–300 Cu/Al
200 A		24	24	QON324L200I	4–300 Cu/Al
200 A		30	30	QON330L200I [29]	4–300 Cu/Al
225 A	42	42	QON342L225I	4–300 Cu/Al	
<b>QO Plug-On Mounting Bases—For unit mounting QO, QO-GFI and QO-EPD circuit breakers</b>					
1Ø2W 240 Vac Max. 10 k AIC (Without Neutral Assembly)	70 A	1	1	QOMB1	14–4 Cu 12–2 Al
	70 A	2	2	QOMB2	14–4 Cu 12–2 Al
	70 A	3	3	QOMB3	14–4 Cu 12–2 Al
<b>QOB Bolt-On Mounting Bases—For unit mounting QOB, QOB-GFI, QOB-EPD circuit breakers</b>					
3Ø3W 240 Vac Max. 10 k AIC (Without Neutral Assembly)	100 A	3	3	QON3B	12–1 Cu/Al



SN12125



QON2L40

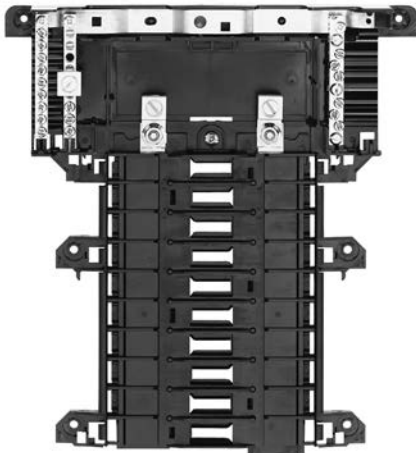

QON120L1251

Table 7.18: Solid Neutral Assemblies

Main Lug Rating	Number of Branch Neutral Terminals	Cat. No.	Main Neutral Lug Wire Size Cu/Al	Branch Neutral Terminal Wire Size	
				Cu	Al
125 A	12	SN12125	4–2/0 AWG	14–4 AWG	12–4 AWG
125 A	20	SN20	4–2/0 AWG	14–4 AWG	12–4 AWG
200 A	12	SN12200	4 AWG–300 kcmil	14–4 AWG	12–4 AWG
200 A	30	SN30	4 AWG–300 kcmil	14–4 AWG	12–4 AWG
225 A	42	SN42	4 AWG–300 kcmil	14–4 AWG	12–4 AWG

Table 7.19: Accessories for US Mounting Base for UL489 C60

Description	Cat. No.
Main lug kit for US mounting bases, 1 lug per kit, for 6 AWG to 300 kcmil cable	USMBLK
Terminal cover for US mounting base; provides IP20 ingress protection per IEC 60529; suitable for jumper bars or cable	USMBTC

[28] Device comes with factory-installed sub-feed lugs.

[29] Also IEC rated and CE marked for IEC 60439-1. Use only Square D brand Type QOXC, QOXD, QOHX and QOE circuit breakers for 415Y/240 Vac max. systems.

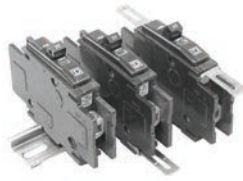

Low Ampere QOU

### Low Ampere QOU Miniature Circuit Breakers

QOU unit mount miniature circuit breakers (cable-in/cable-out) are ideal for OEM applications. They have the Square D™ circuit breaker's unique Visi-Trip™ feature and can be DIN rail-mounted or surface- or flush-mounted using mounting feet. Mounting feet not provided [30].

#### General Specifications Common to All Low Ampere QOU Circuit Breakers

- For convenient flush mount, surface mount or DIN mount (symmetrical rail 35 x 7.5 DIN/EN 50 022)
- Single handle with internal common trip
- Terminal lug wire size (1) 14–2 AWG Cu or Al
- Reversible line and load lugs
- Field-installable quick connectors
- UL Listed 48 Vdc (5 k AIR)
- UL Listed as HACR Type: 10–70 A
- High magnetic trip circuit breakers (QOU-HM) are recommended for applications where high initial inrush may occur and for individual dimmer applications.
- For DIN mounting rails, see IEC Starters and Relays, Section 18.

**Table 7.20: QOU Low Ampere Miniature Circuit Breakers**

Ampere Rating	Cat. No.			
	1P 120/240 Vac	2P 120/240 Vac	2P 240 Vac [31]	3P 240 Vac
<b>10 k AIR</b>				
10 A	QOU110	QOU210	—	QOU310
15 A	QOU115	QOU215	QOU215H	QOU315
20 A	QOU120	QOU220	QOU220H	QOU320
25 A	QOU125	QOU225	QOU225H	QOU325
30 A	QOU130	QOU230	QOU230H	QOU330
35 A	QOU135	QOU235	—	QOU335
40 A	QOU140	QOU240	—	QOU340
45 A	QOU145	QOU245	—	QOU345
50 A	QOU150	QOU250	—	QOU350
60 A	QOU160	QOU260	—	QOU360
70 A	QOU170	QOU270	—	QOU370
<b>22 k AIR</b>				
15 A	QOU115VH	QOU215VH	—	QOU315VH
20 A	QOU120VH	QOU220VH	—	QOU320VH
25 A	QOU125VH	QOU225VH	—	QOU325VH
30 A	QOU130VH	QOU230VH	—	QOU330VH
35 A	QOU135VH	QOU235VH	—	—
40 A	QOU140VH	QOU240VH	—	—
45 A	QOU145VH	QOU245VH	—	—
50 A	QOU150VH	QOU250VH	—	—
60 A	QOU160VH	QOU260VH	—	—

**Table 7.21: QOU-HM Miniature Circuit Breakers (10 k AIR)**

Ampere Rating	Cat. No.			
	1P 120/240 Vac	2P 120/240 Vac	2P 240 Vac	3P 240 Vac
15 A	QOU115HM	—	—	—
20 A	QOU120HM	—	—	—

**Table 7.22: QYU UL1077 Recognized Supplementary Protectors (5 k AIR)**

Ampere Rating	Cat. No.			
	1P 277 Vac	2P 120/240 Vac	2P 240 Vac	3P 240 Vac
10 A	QYU110	—	—	—
15 A	QYU115	—	—	—
20 A	QYU120	—	—	—
25 A	QYU125	—	—	—
30 A	QYU130	—	—	—

[30] See QOU Accessories, page 7-19.  
[31] QOU-H interrupting rating is 10 kA at 240 Vac.



High Ampere QOU

### High Ampere QOU Circuit Breakers

#### General Specifications Common to All High Ampere QOU Circuit Breakers

- Flush mount, surface mount, and DIN rail mount.
- Internal common trip.
- Non-reversible line and load lugs.
- Terminal lug wire size (1) 12– 2/0 AWG Cu or Al.
- UL Listed 60 Vdc per pole (5 k AIR). (**Note:** except switches)
- UL Listed as HACR type, 80–125 A.
- Non-automatic switches have the same physical packaging as miniature circuit breakers, but provide no overcurrent or short circuit protection. They are UL Listed per UL1087 and are CSA certified.

**Table 7.23: QOU High Ampere Miniature Circuit Breakers (10 k AIR)**

Ampere Rating	Cat. No.			
	1P 120/240 Vac	2P 120/240 Vac	2P 240 Vac	3P 240 Vac
80 A	QOU180	QOU280	—	QOU380
90 A	QOU190	QOU290	—	QOU390
100 A	QOU1100	QOU2100	—	QOU3100
125 A	—	QOU2125	—	—

**Table 7.24: QOU Non-Automatic Switches**

Ampere Rating	Cat. No.			
	1P 120 Vac	2P 120/240 Vac	2P 240 Vac	3P 240 Vac
60 A	—	—	QOU200	QOU300
100 A	—	—	QOU2000	QOU3000
125 A	—	—	QOU20001	QOU30001

Interrupting ratings see page 7-3

Accessories see page 7-19

Dimensions see page 7-74

**QOU Accessories**

**Table 7.25: Accessories for QOU Low Ampere Circuit Breakers (Except as Noted)**

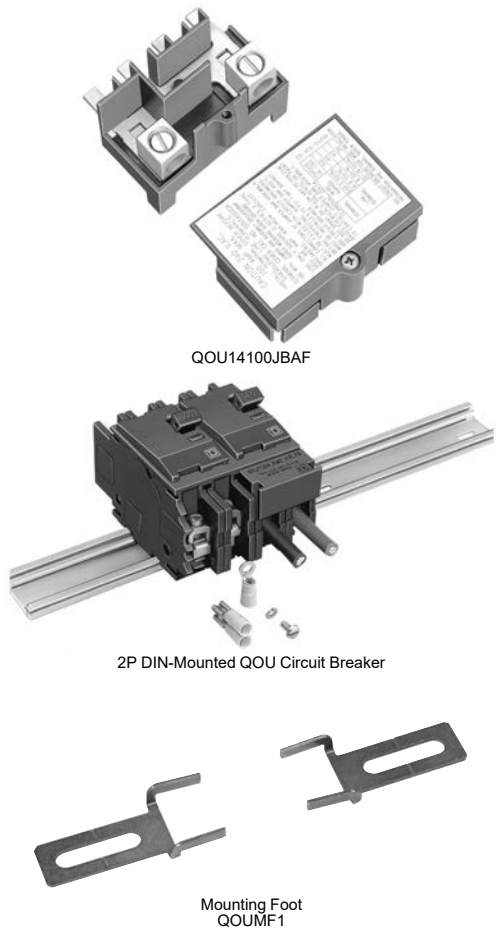

Description	Order Qty.	Cat. No.
Factory-installed ring tongue terminal, 10–32 screw, for 1P, 2P, 3P QOU, 10–60 A	—	Suffix -5283
Hex drive 5/32 in. wire binding screw for QOU	—	Suffix -5280
For padlocking 1P low ampere QOU circuit breaker in OFF or ON position	—	QOU1PA
For padlocking 2P and 3P low ampere QOU circuit breaker in OFF or ON position	—	QOU1PL
For padlocking 1P low ampere QOU circuit breaker in OFF position only	—	QOU1PAFLA
For padlocking 2P and 3P low ampere QOU circuit breaker in OFF position only	—	QOU2PAFLA
For padlocking 2P and 3P high ampere QOU circuit breaker in OFF position only	—	Suffix -7100
Handle lock-out, ON or OFF position	—	HLO1
4P 100 A Jumper bar assy. w/front wiring with base, cover and screw	1	QOU14100JBAF
4P 100 A Jumper bar assy. w/right side wiring with base, cover and screw	1	QOU14100JBAR
4P 100 A Jumper bar assy. w/left side wiring with base, cover and screw	1	QOU14100JBAL
1Ø, 4P, 100 A Jumper bar base with front wiring	40	QOU14100BAFB
1Ø, 4P, 100 A Jumper bar base with left side wiring	40	QOU14100BALB
1Ø, 4P, 100 A Jumper bar base with right side wiring	40	QOU14100BARB
4P Jumper bar cover	40	QOU14100CAB
Mounting screw for jumper bar cover	40	QOU1CMSB
6P 150 A Jumper bar assy. w/front wiring with base, cover and screw	1	QOU16150JBAF
1Ø, 6P, 150 A Jumper bar base with front wiring	40	QOU16150BAFB
1Ø, 6P, 150 A Jumper bar base with left side wiring	40	QOU16150BALB
1Ø, 6P, 150 A Jumper bar base with right side wiring	40	QOU16150BARB
6P jumper bar cover	40	QOU16150CAB
Vertical rainproof cover 2P and 3P QO, QOU, FA and KA	1 10	BCV [32] BCVB [32]
Horizontal rainproof cover 2P QO, QOU, and 3P Q2, EH	1 10	BCH [32] BCHB [32]
1P Fingersafe™ cover for high ampere QOU circuit breaker	1 40	QOUHFSC1 QOUHFSC1B
1P Fingersafe cover for low ampere QOU circuit breaker	1 40	QOULFSC1 QOULFSC1B
Cover plate for one 2P QOU circuit breaker	1 40	QOUCP2 QOUCP2B
Cover plate for one 3P QOU circuit breaker	1 40	QOUCP3 QOUCP3B
Cover plate for two 2P QOU circuit breakers	1 40	QOUCP4 QOUCP4B
Cover plate for three 2P QOU circuit breakers	1 40	QOUCP6 QOUCP6B
Field-installable ring tongue terminal adaptor	1 80	QOURT QOURTB
Quick connector end connection wiring	1 40	QOUFC QOUFCB
Quick connector forward or reverse wiring	1 40	QOUFR QOUFRB
1P QOU mounting foot	1 80	QOUMF1 [32] QOUMF1B [32]
2P QOU mounting foot	1 40	QOUMF2 [32] QOUMF2B [32]
3P QOU mounting foot	1 24	QOUMF3 [32] QOUMF3B [32]
Tapped mounting foot for QOU, 1P and 2P 10–70 A, 3P 10–60 A		
Packaged with circuit breaker		Suffix -3100
Individually packaged	1	QOUMFS1
Bulk packed	80	QOUMFS1B
Mechanical interlock attachment: Used to interlock two circuit breakers mounted side-by-side so that only one circuit breaker can be ON at a time. A 1P or 2P circuit breaker can be mounted on the left and interlocked with a 2P or 3P circuit breaker on the right.	1	QOU2DTILA [33]

**QOUQ Low Ampere Circuit Breakers**

QOUQ low ampere circuit breakers with four-point quick-connect terminals are provided with permanent factory-installed terminals which are affixed to the Load or OFF end of the circuit breaker. This special terminal will accommodate up to four 1/4-inch insulated female quick connect wire terminations. Total ampacity of these connections must not exceed the rating of the circuit breaker.

**Table 7.26: QOUQ Four-Point Quick-Connect Terminals**

	Poles	Order Qty.	Cat. No.
Four-Point Quick-Connect Terminals	1	1	Change QOU to QOUQ
	2	1	
	3	1	

The QOU uses the same electrical accessories as the QO. See the QO information for available electrical accessories.

[32] For use on low and high ampere QOU.  
[33] 10–70 A 1P and 2P, 10–60 A 3P.

### Homeline Plug-On Circuit Breakers

The Square D Homeline circuit breakers are in a 1 in. wide format for 1-pole circuit breakers. They are designed to plug into Homeline load centers.



Table 7.27: HOM

Ampere Rating	AIR	1P—120/240 Vac Cat. No.	2P—120/240 Vac Common Trip Cat. No.
15 A	10 kA	HOM115 [1][2]	HOM215 [2]
20 A	10 kA	HOM120 [1][2]	HOM220 [2]
25 A	10 kA	HOM125 [2]	HOM225 [2]
30 A	10 kA	HOM130 [2]	HOM230 [2]
35 A	10 kA	—	HOM235 [2]
40 A	10 kA	HOM140 [2]	HOM240 [2]
45 A	10 kA	—	HOM245 [2]
50 A	10 kA	HOM150 [2]	HOM250 [2]
60 A	10 kA	—	HOM260 [2]
70 A	10 kA	—	HOM270 [2]
80 A	10 kA	—	HOM280 [2]
90 A	10 kA	—	HOM290 [2]
100 A	10 kA	—	HOM2100 [2]
110 A	10 kA	—	HOM2110 [2]
125 A	10 kA	—	HOM2125 [2]
150 A	10 kA	—	HOM2150BB [2][3]
175 A	10 kA	—	HOM2175BB [2][3]
200 A	10 kA	—	HOM2200BB [2][3]

### Homeline High Magnetic (HM) Circuit Breakers

High magnetic trip circuit breakers are recommended for applications where high initial inrush current may occur.

Table 7.28: HOM-HM

Amperes	1P—120/240 Vac	2Ps
15 A	HOM115HM [4]	—
20 A	HOM120HM [4]	—

### Homeline Combination Arc Fault Circuit Interruptors (HOM-CAFI)

Homeline Combination Arc Fault Circuit Interruptors—Provide overload and short circuit protection, plus arc fault protection in accordance with the NEC and UL 1699.



Table 7.29: HOM-CAFI

Circuit Breaker Type	Ampere Rating	Poles 120 Vac	Cat. No.
<b>One-Pole</b>			
Combination Arc-Fault Circuit Interrupter with Pigtail Neutral	15 A	1	HOM115CAFI [4]
	20 A	1	HOM120CAFI [4]
Plug-On Neutral Combination Arc-Fault Interrupter	15 A	1	HOM115PCAIFI [4]
	20 A	1	HOM120PCAIFI [4]
<b>Two-Pole</b>			
Combination Arc-Fault Circuit Interrupter with Pigtail Neutral	15 A	2	HOM215CAFI [4] [5]
	20 A	2	HOM220CAFI [4] [5]

### Homeline Dual Function Circuit Breaker (HOM-DF)

Homeline Combination Arc Fault and Ground Fault Circuit Interrupters (Dual Function)—Provide overload and short circuit protection, plus arc fault and ground fault protection in a single device in accordance with the NEC, UL 1699 and UL943.



Table 7.30: HOM-DF

Circuit Breaker Type	Ampere Rating	Poles 120 Vac	Cat. No.
Combination Arc-Fault and Ground Fault Circuit Interrupter with Pigtail Neutral	15 A	1	HOM115DF [4]
	20 A	1	HOM120DF [4]
Plug-On Neutral Combination Arc-Fault and Ground Fault Circuit Interrupter	15 A	1	HOM115PDF [4]
	20 A	1	HOM120PDF [4]

[1] UL Listed as SWD (switching duty) rated. Suitable for switching 120 Vac fluorescent lighting loads.

[2] UL Listed as HACR type for use with air conditioning, heating and refrigeration equipment having motor group combinations and marked for use with HACR type circuit breakers.

[3] Requires four spaces (1 AWG–300 kcmil Al/Cu). Use only in 1Ø panel rated 150 A or greater.

[4] UL Listed as HACR type for use with air conditioning, heating and refrigeration equipment having motor group combinations and marked for use with HACR type circuit breakers.

[5] For 120/240 V only, not for 208Y/120 V.



HOM 1P GFI  
(With Ground Fault  
Circuit Interrupter)  
1 Space Required



HOM 2P GFI  
(With Ground Fault  
Circuit Interrupter)  
2 Spaces Required

### Homeline GFI (HOM-GFI)

HOM-GFI circuit breakers provide overload and short circuit protection, combined with Class A ground fault protection. Class A denotes a ground fault circuit interrupter that will trip when a fault current to ground is 6 milliamperes or more.

**Table 7.31: HOM-GFI**

Ampere Rating	AIR	1P—120 Vac 1 Space Required	2P—120/240 Vac Common Trip 2 Spaces Required
15 A	10 kA	HOM115GFI	HOM215GFI
20 A	10 kA	HOM120GFI	HOM220GFI
30 A	10 kA	—	HOM230GFI
40 A	10 kA	—	HOM240GFI
50 A	10 kA	—	HOM250GFI

### Homeline Equipment Protection Device (HOM-EPD)

Homeline Equipment Protection Device—Circuit Breakers with 30 mA Equipment Ground Fault Protection (UL Listed).

**Table 7.32: HOM-EPD—10 k AIR**

Amperes	1P—120 Vac	2P—120/240 Vac Common Trip
15 A	HOM115EPD	HOM215EPD
20 A	HOM120EPD	HOM220EPD
25 A	—	HOM225EPD
30 A	—	HOM230EPD
40 A	—	HOM240EPD
50 A	—	HOM250EPD

### HOMT Tandem and HOMT Quad Tandem Circuit Breakers

**Table 7.33: HOMT Tandem Circuit Breakers**

Ampere Rating [6]	AIR	1P Tandem—120/240 Vac (One Space Required)
15 and 15 A	10 kA	HOMT1515 [7]
15 and 20 A	10 kA	HOMT1520 [7]
20 and 20 A	10 kA	HOMT2020 [7]
30 and 15 A	10 kA	HOMT3015 [7]
30 and 20 A	10 kA	HOMT3020 [7]



HOMT Quad  
Circuit Breaker  
2 Spaces Required

**Table 7.34: HOMT Quad Tandem Circuit Breakers**

Ampere Rating [6]		AIR	2P Tandem—120/240 Vac (Two Spaces Required)
1P	2P		
(2) 15 A	15 A	10 kA	HOMT1515215 [7]
(2) 15 A	20 A	10 kA	HOMT1515220 [7]
(2) 15 A	25 A	10 kA	HOMT1515225 [7]
(2) 15 A	30 A	10 kA	HOMT1515230 [7]
(2) 15 A	40 A	10 kA	HOMT1515240 [7]
(2) 15 A	50 A	10 kA	HOMT1515250 [7]
(2) 20 A	20 A	10 kA	HOMT2020220 [7]
(2) 20 A	25 A	10 kA	HOMT2020225 [7]
(2) 20 A	30 A	10 kA	HOMT2020230 [7]
(2) 20 A	40 A	10 kA	HOMT2020240 [7]
(2) 20 A	50 A	10 kA	HOMT2020250 [7]

**NOTE:** Typical catalog number (e.g. HOMT 1515230) represents two 1P, outer poles (two 15 A 1P CBs) and one 2P inner circuit breaker with common trip (one 30 A 2P CB).

[6] 15–20 A tandem or quad tandem circuit breakers are suitable for use with 60°C or 75°C conductors. 25–50 A tandem or quad tandem circuit breakers are suitable for use with 75°C conductors only.  
[7] UL Listed as HACR type for use with air conditioning, heating and refrigeration equipment having motor group combinations and marked for use with HACR type circuit breakers.

Homeline Circuit Breaker Wire Sizes

Table 7.35: Circuit Breaker Wire Sizes

Breaker Type	Ampere Rating	Wire Size (AWG/kcmil) [8]	
		Aluminum	Copper
HOM 1P	15–30 A	14–8 AWG	14–8 AWG or (2) 14–10 AWG
	40–50 A	8–2 AWG	8–2 AWG
HOM 2P	15–30 A	14–8 AWG	14–8 AWG or (2) 14–10 AWG
	35–70 A	8–2 AWG	8–2 AWG
	80–125 A	4–2/0 AWG	4–2/0 AWG
	150–200 A	4 AWG–300 kcmil	4 AWG–300 kcmil
HOMT and Quad	15–30 A	14–8 AWG	14–8 AWG
Quad Only	40–50 A	6–12 AWG	6–14 AWG
HOM-GFI - 1P	15–20 A	14–10 AWG	14–10 AWG
HOM-GFI - 2P	15–50 A	12–4 AWG	14–6 AWG

Accessories for Homeline Circuit Breakers

Table 7.36: Accessories

Description	Cat. No.	
<b>Handle Attachments</b>		
Handle Tie: Converts any two adjacent 120/240 Vac single HOM circuit breakers to independent trip 2P	HOM1HT	
Handle Tie: Converts any two adjacent 120/240 Vac 1P side-by-side HOMT circuit breakers to independent trip 2P	HOMTHT	
Handle Clamp: Clamp for holding HOM 1P handle in the ON or OFF position	QO1LO	
Handle Blocking Device: Attaches to standard HOM 2P circuit breakers for holding the handle in the OFF position	HOM2HBD	
Handle Padlock Attachment: For padlocking 1P Standard HOM breakers in the ON or OFF position	HOM1PA	
Handle Padlock Attachment: For padlocking 2P Standard HOM circuit breakers in ON or OFF position	15–70 A	HOM2PALA
	80–125 A	HOM2PAHA
	150–200 A	HOM2PAVHA
Handle Padlock Attachment: For padlocking 1P CAFI, DF, GFI, and EPD HOM breakers in ON or OFF position	HOMELEC1PA	
Handle Padlock Attachment: For padlocking 2P CAFI, GFI, and EPD HOM breakers in ON or OFF position	HOMELEC2PALA	
Handle Padlock Attachment: For padlocking center poles of Homeline Quad breakers in the OFF position	HOMQPA	
Handle Padlock Attachment: For padlocking main circuit breakers in convertible load center in OFF position	50–125 A	QOM1PA [9]
	100–225 A	QOM2PA [9]
<b>Sub-Feed Lugs</b>		
125 A 2P plug-on—2 spaces required	HOML2125	
225 A 2P plug-on—4 spaces required	HOML2225 [10]	

[8] 15–30 A circuit breakers are suitable for use with 60°C or 75°C conductors. 40–125 A circuit breakers are suitable for use with 75°C conductors.

[9] 50–125 A QOM1 frame size; 100–225 A QOM2 frame size.

[10] Requires four spaces (1 AWG–300 kcmil Al/Cu). Use only in 1Ø panel rated 150 A or greater.



UL489 / CSA C22.2 No 5 / IEC/EN 60947-2 / GB14048-2  
Miniature Circuit Breakers

**Multi 9 C60<sub>BP</sub> and C60<sub>BPR</sub> Miniature Circuit Breakers**

C60<sub>BP</sub> and C60<sub>BPR</sub> are multi-standard miniature circuit breakers and branch circuit protection as defined by UL489. They combine the following functions:

- circuit protection against short-circuit curves
- circuit protection against overload currents
- tripping and fault indication by the addition of auxiliary accessories

Number of 18 mm (0.71 in.) Poles	Rating (A) 25°C/77°F	Breaking Capacity (kA rms)							
		UL 489 / CSA C22.2 No 5				IEC 60947-2			
		AIR		Icu		Icu		Icu	
	Voltage (Ue)	277 Vac	240 Vac	120 Vac	60 Vdc	440 Vac	415 Vac	240 Vac	60 Vdc
1P	0.5 to 35	10	14	14	10	—	3	10	20
	40 to 63	—	10	10	10	—	3	10	20
	Voltage (Ue)	480Y/277 Vac		240 Vac	125 Vdc	440 Vac	415 Vac	240 Vac	125 Vdc
2P	1 to 25	10	14	10	6	10	20	—	—
	30 to 35	10	14	—	6	10	20	—	—
3P	1 to 35	10	14	—	6	10	20	—	—
2P/3P	40 to 63	—	10	—	6	10	20	—	—

**Table 7.37: C60<sub>BP</sub> and C60<sub>BPR</sub> Catalog Numbers**



Type	UL489 and CSA Voltages	1P			2P		3P	
		Curve			Curve		Curve	
		Z	C	D (= K)	C	D (= K)	C	D (= K)
<b>C60<sub>BP</sub> (Tunnel Terminal Connection)</b>								
0.5	480Y/277 V and 240 V	M9F44170	M9F42170	M9F43170	—	—	—	—
1		M9F44101	M9F42101	M9F43101	M9F42201	M9F43201	M9F42301	M9F43301
2		M9F44102	M9F42102	M9F43102	M9F42202	M9F43202	M9F42302	M9F43302
3		M9F44103	M9F42103	M9F43103	M9F42203	M9F43203	M9F42303	M9F43303
4		M9F44104	M9F42104	M9F43104	M9F42204	M9F43204	M9F42304	M9F43304
5		M9F44105	M9F42105	M9F43105	M9F42205	M9F43205	M9F42305	M9F43305
6		M9F44106	M9F42106	M9F43106	M9F42206	M9F43206	M9F42306	M9F43306
8		M9F44108	M9F42108	M9F43108	M9F42208	M9F43208	M9F42308	M9F43308
10		M9F44110	M9F42110	M9F43110	M9F42210	M9F43210	M9F42310	M9F43310
15		M9F44115	M9F42115	M9F43115	M9F42215	M9F43215	M9F42315	M9F43315
20		M9F44120	M9F42120	M9F43120	M9F42220	M9F43220	M9F42320	M9F43320
25		M9F44125	M9F42125	M9F43125	M9F42225	M9F43225	M9F42325	M9F43325
30		M9F44130	M9F42130	M9F43130	M9F42230	M9F43230	M9F42330	M9F43330
35		M9F44135	M9F42135	M9F43135	M9F42235	M9F43235	M9F42335	M9F43335
40		M9F44140	M9F42140	M9F43140	M9F42240	M9F43240	M9F42340	M9F43340
45		M9F44145	M9F42145	M9F43145	M9F42245	M9F43245	M9F42345	M9F43345
50		M9F44150	M9F42150	M9F43150	M9F42250	M9F43250	M9F42350	M9F43350
63		M9F44163	M9F42163	M9F43163	M9F42263	M9F43263	M9F42363	M9F43363
<b>C60<sub>BPR</sub> (Ring Tongue Terminal Connection)</b>								
1	480Y/277 V and 240 V	M9F54101	M9F52101	M9F53101	M9F52201	M9F53201	M9F52301	M9F53301
2		M9F54102	M9F52102	M9F53102	M9F52202	M9F53202	M9F52302	M9F53302
4		M9F54104	M9F52104	M9F53104	M9F52204	M9F53204	M9F52304	M9F53304
6		M9F54106	M9F52106	M9F53106	M9F52206	M9F53206	M9F52306	M9F53306
8		M9F54108	M9F52108	M9F53108	M9F52208	M9F53208	M9F52308	M9F53308
10		M9F54110	M9F52110	M9F53110	M9F52210	M9F53210	M9F52310	M9F53310
15		M9F54115	M9F52115	M9F53115	M9F52215	M9F53215	M9F52315	M9F53315
20		M9F54120	M9F52120	M9F53120	M9F52220	M9F53220	M9F52320	M9F53320
25		M9F54125	M9F52125	M9F53125	M9F52225	M9F53225	M9F52325	M9F53325
30		M9F54130	M9F52130	M9F53130	M9F52230	M9F53230	M9F52330	M9F53330
35		M9F54135	M9F52135	M9F53135	M9F52235	M9F53235	M9F52335	M9F53335
40		M9F54140	M9F52140	M9F53140	M9F52240	M9F53240	M9F52340	M9F53340
45		M9F54145	M9F52145	M9F53145	M9F52245	M9F53245	M9F52345	M9F53345
50		M9F54150	M9F52150	M9F53150	M9F52250	M9F53250	M9F52350	M9F53350
63		M9F54163	M9F52163	M9F53163	M9F52263	M9F53263	M9F52363	M9F53363



**Multi 9 C60<sub>SP</sub> Miniature Circuit Breakers**

C60<sub>SP</sub> circuit breakers are multi-standard miniature circuit breakers and supplementary protection as defined by UL1077. They combine the following functions:

- circuit protection against short-circuit curves
- circuit protection against overload currents
- tripping and fault indication by the addition of auxiliary accessories

Number of 18 mm (0.71 in.) Poles	Rating (A) 25°C/77°F	Breaking capacity (kA rms)							
		AIR UL 489 / CSA C22.2 No 235				Icu IEC 60947-2			
1P	Voltage (Ue)	277 Vac	240 ac	120 Vac	65 Vdc	440 Vac	415 Vac	240 Vac	60 Vdc
	0.5 to 32 40 to 63	10 5	14 10	14 10	10 10	— —	3 3	10 10	20 20
2P	Voltage (Ue)	480Y/277 Vac		240 Vac	125 Vdc	440 Vac	415 Vac	240 Vac	125 Vdc
	1 to 25 32	10		14	10	6	10	20	—
3P/4P	2 to 32	10		14	—	6	10	20	—
2P/3P/4P	40 to 63	5		10	—	6	10	20	—

**Table 7.38: C60<sub>SP</sub> Catalog Numbers**

Rating (In)	Tunnel Terminal Connection					
	Curve			Curve		
	B	C	D (= K)	B	C	D (= K)
	1P			2P		
0.5	M9F21170	M9F22170	M9F23170	—	—	—
1	M9F21101	M9F22101	M9F23101	M9F21201	M9F22201	M9F23201
2	M9F21102	M9F22102	M9F23102	M9F21202	M9F22202	M9F23202
3	M9F21103	M9F22103	M9F23103	M9F21203	M9F22203	M9F23203
4	M9F21104	M9F22104	M9F23104	M9F21204	M9F22204	M9F23204
5	M9F21105	M9F22105	M9F23105	M9F21205	M9F22205	M9F23205
6	M9F21106	M9F22106	M9F23106	M9F21206	M9F22206	M9F23206
8	M9F21108	M9F22108	M9F23108	M9F21208	M9F22208	M9F23208
10	M9F21110	M9F22110	M9F23110	M9F21210	M9F22210	M9F23210
13	M9F21113	M9F22113	M9F23113	M9F21213	M9F22213	M9F23213
16	M9F21116	M9F22116	M9F23116	M9F21216	M9F22216	M9F23216
20	M9F21120	M9F22120	M9F23120	M9F21220	M9F22220	M9F23220
25	M9F21125	M9F22125	M9F23125	M9F21225	M9F22225	M9F23225
32	M9F21132	M9F22132	M9F23132	M9F21232	M9F22232	M9F23232
40	M9F21140	M9F22140	M9F23140	M9F21240	M9F22240	M9F23240
45	M9F21145	M9F22145	M9F23145	M9F21245	M9F22245	M9F23245
50	M9F21150	M9F22150	M9F23150	M9F21250	M9F22250	M9F23250
63	M9F21163	M9F22163	M9F23163	M9F21263	M9F22263	M9F23263
	3P			4P		
0.5	—	—	—	—	—	—
1	—	—	—	—	—	—
2	M9F21302	M9F22302	M9F23302	M9F21402	M9F22402	M9F23402
3	—	—	—	—	—	—
4	—	—	—	—	—	—
5	—	—	—	—	—	—
6	M9F21306	M9F22306	M9F23306	M9F21406	M9F22406	M9F23406
8	M9F21308	M9F22308	M9F23308	M9F21408	M9F22408	M9F23408
10	M9F21310	M9F22310	M9F23310	M9F21410	M9F22410	M9F23410
13	M9F21313	M9F22313	M9F23313	M9F21413	M9F22413	M9F23413
16	M9F21316	M9F22316	M9F23316	M9F21416	M9F22416	M9F23416
20	M9F21320	M9F22320	M9F23320	M9F21420	M9F22420	M9F23420
25	M9F21325	M9F22325	M9F23325	M9F21425	M9F22425	M9F23425
32	M9F21332	M9F22332	M9F23332	M9F21432	M9F22432	M9F23432
40	M9F21340	M9F22340	M9F23340	M9F21440	M9F22440	M9F23440
45	M9F21345	M9F22345	M9F23345	M9F21445	M9F22445	M9F23445
50	M9F21350	M9F22350	M9F23350	M9F21450	M9F22450	M9F23450
63	M9F21363	M9F22363	M9F23363	M9F21463	M9F22463	M9F23463





UL 1077, IEC/EN 60947-2, GB14048.2  
Multi 9 Miniature Circuit Breakers

**Multi 9 C60<sub>H-DC</sub> Miniature Circuit Breakers for DC Circuits**

C60<sub>H-DC</sub> circuit breakers are multi-standard miniature circuit breakers and supplementary protection as defined by UL1077, dedicated to direct current applications. They combine the following functions:

- circuit protection against short-circuit curves
- circuit protection against overload currents
- tripping and fault indication by the addition of auxiliary accessories

Number of 18 mm (0.71 in.) Poles	Rating (A) 25°C/77°F	Breaking capacity (kA rms)				
		AIR UL 1077SA C22.2 No 5	Icu IEC 60947-2			
Voltage (Ue)		12–250 Vdc	110 Vdc	220 Vdc	250 Vdc	
1P	0.5 to 63	5	20	10	6	
Voltage (Ue)		12–250 Vdc		220 Vdc	440 Vdc	500 Vdc
2	0.5 to 63	5	—	20	10	6

**Table 7.39: C60<sub>H-DC</sub> Catalog Numbers**

Rating (In)	Curve			Curve		
	B	C	K (= D)	B	C	K (= D)
	1P			2P		
0.5	—	M9U21170	—	—	M9U21270	—
1	—	M9U21101	M9U31101	—	M9U31201	M9U31201
2	—	M9U21102	M9U31102	—	M9U21202	M9U31202
3	—	M9U21103	M9U31103	—	M9U21203	M9U31203
4	—	M9U21104	M9U31104	—	M9U21204	M9U31204
6	M9U11106	M9U21106	M9U31106	M9U11206	M9U21206	M9U31206
10	M9U11110	M9U21110	M9U31110	M9U11210	M9U21210	M9U31210
13	M9U11113	M9U21113	M9U31113	M9U11213	M9U21213	M9U31213
16	M9U11116	M9U21116	M9U31116	M9U11216	M9U21216	M9U31216
20	M9U11120	M9U21120	M9U31120	M9U11220	M9U21220	M9U31220
25	M9U11125	M9U21125	M9U31125	M9U11225	M9U21225	M9U31225
32	M9U11132	M9U21132	M9U31132	M9U11232	M9U21232	M9U31232
40	M9U11140	M9U21140	M9U31140	M9U11240	M9U21240	M9U31240
50	M9U11150	M9U21150	M9U31150	M9U11250	M9U21250	M9U31250
63	M9U11163	M9U21163	M9U31163	M9U11263	M9U21263	M9U31263



C60<sub>H-DC</sub> 1P



C60<sub>H-DC</sub> 2P



UL 1053, IEC/EN 61008  
Multi 9 Ground Fault Protectors



Multi 9 GFP 2P



Multi 9 GFP 4P

**Multi 9 GFP Ground Fault Protectors**

UL 1053 residual current circuit breakers already protected upstream by a short circuit and overload protection device are used for:

- control and disconnection of electric circuits
- protection of people against electric shock by direct and indirect contacts
- protection of installations against insulation faults
- enhanced continuity of supply, during a series of close lightning strokes, IT earthing system, equipment including interference suppression filters, variable speed controllers, frequency converters, electronic ballasts for lighting
- enhanced earth leakage protection: in presence of harmonics or high frequency ejections.

A-SI type GFPs are ideal for operation in environments with a humid atmosphere and/or polluted by aggressive agents: swimming pools, marinas, agri-food industries, water treatment stations, industrial sites, etc.

**Table 7.40: GFP UL 1053 Type A-SI**

A-S1 Type	Rating (A)	Sensitivity (mA)		Catalog No		Width in modules of 9 mm (0.354 in.)
		UL 1053	IEC/ EN 61008	120 or 240 V 230 or 240 V	240 V 480Y/277 V 230/400 or 240/415 V	
<b>2P</b>						
	25	26	30	M9R81225	M9R41225	4
		86	100	M9R12225	M9R44225	
		260	300	M9R84225	—	
	40	26	30	M9R81240	M9R41240	
		260	300	M9R84240	—	
	63	26	30	M9R81263	—	
<b>4P</b>						
	25	26	30	—	M9R81425	8
		86	100	—	M9R12425	
		260	300	—	M9R84425	
	40	26	30	—	M9R81440	
		260	300	—	M9R84440	
	63	26	30	—	M9R81463	
		86	100	—	M9R12463	
	100	86	100	—	M9R12491	
		260	300	—	M9R84491	



**C60<sub>BP</sub> (UL489) Comb Busbars**

These comb busbars are aimed to be used only with C60<sub>BP</sub> circuit-breakers.

They perform distribution and subdistribution of the electric power supply and allow rapid assembly and disassembly of equipment.

**Table 7.41: C60<sub>BP</sub> Comb Busbars**

Connection Accessories	Comb Busbars						Insulated Connectors	Tooth Covers	End-Piece
Function	<ul style="list-style-type: none"> <li>The comb busbars make it easier to install C60<sub>BP</sub> UL489 circuit breakers.</li> <li>They must not be cut.</li> </ul>						<ul style="list-style-type: none"> <li>Comb busbar power supply</li> <li>Vertical incoming feeder</li> </ul>	<ul style="list-style-type: none"> <li>Insulation of teeth remaining free</li> </ul>	<ul style="list-style-type: none"> <li>Ensures the correct comb busbar insulation</li> </ul>
Use	Power supply by insulated connector <ul style="list-style-type: none"> <li>Use with rigid and flexible copper cable</li> <li>6 to 35 mm<sup>2</sup> (AWG #10 to #2):</li> </ul>						Tightening torque: 3.5 N•m (31 lb.in.)		
Standard Comb Busbars									
Number of poles	1P		2P		3P		All	All	—
Catalogue numbers	M9XUP106	M9XUP312	M9XUP312	M9XUP312	M9XUP312	M9R81425	M9XUPC04	M9XCTC18	—
Number of 18 mm modules	6	12	6	12	6	12	—	—	—
Set of	1		1		1		4	5 x 3	—
Cuttable Comb Busbars									
Number of poles x	1P	2P	3P	1P+Aux		3P+Aux	All	All	—
Catalogue numbers	M9XCP157	M9XCP256	M9XCP357	M9XCA137	M9XCA348		M9XCPC04	M9XUTC18	M9XCEC10
Number of 18 mm modules	57	56	57	37	37		—	—	—
Set of	1		1		1		4	5 x 3	—
Technical Specifications	Acceptable current at 40°C (I <sub>e</sub> ) Standard comb busbars: 115 A Cuttable comb busbars: 80 A								
Resistance to short-circuit currents	Compatible with the breaking capacity of Schneider Electric modular circuit breakers								
Voltage rating (U <sub>e</sub> )	480Y/277 V								
Insulation voltage (U <sub>i</sub> )	1000 V AC								
Pollution degree	3								
Fire resistance	Self-extinguishability 960°C 30 s/30 s								
Colour	RAL 7035								
Standards	UL508								





**C60<sup>SP</sup> (UL1077) Comb Busbars**

The comb busbars are used only for C60<sup>SP</sup> circuit breakers UL 1077 supplementary protection in conformity with standards:

- UL 1077 / CSA C22.2 No. 235 / IEC 60947-2 / GB 14048-2.

They perform distribution and subdistribution of the electric power supply and allow rapid assembly and disassembly of equipment.

**Table 7.42: C60<sup>SP</sup> Comb Busbars**

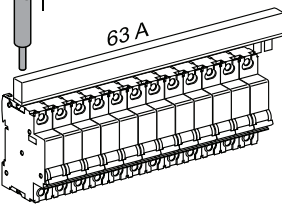
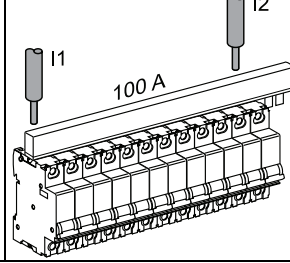
Connection Accessories	Comb Busbars			Tooth Cover End-Piece
				
Function	<ul style="list-style-type: none"> <li>• The comb busbars make it easier to install Schneider Electric circuit breakers UL1077 supplementary protection.</li> <li>• Power supply directly in the cage of the circuit breaker.</li> </ul>			<ul style="list-style-type: none"> <li>• The Tooth Caps are insulated protectors which may be slipped onto the unused teeth of the comb busbar.</li> <li>• They come in strips with 1-pole spacing, but can be snapped apart to be used individually.</li> </ul>
Number of poles	1P	2P	3P	All
Voltage rating (Ue)	480Y/277 Vac	480Y/277 Vac	480Y/277 Vac	—
Catalogue numbers	10285	10286	10287	60488
Number of 18 mm modules	12 (8.5 in./216 mm)	12 (8.5 in./216 mm)	12 (8.5 in./216 mm)	—
Set of	1	1	1	20
<b>Technical Specifications</b>				
Insulation voltage (Ui)	690 Vac			—
Impulse withstand voltage (Uimp)	12 kV under 240 V 5 kV under 480Y/277 V or 277 V			—
Acceptable current at 40°C (Ie)	63 A with 1 central power supply point		100 A with 2 power supply points	—
				—
	Power supply via cable directly in the cage of the device:			—
	<ul style="list-style-type: none"> <li>• cross section max: 3 AWG (25 mm<sup>2</sup>)</li> <li>• cross section min: 10 AWG (5.27 mm<sup>2</sup>)</li> </ul>			—

**Multi 9 C60 Accessories**

Electrical Accessories for C60 Circuit Breakers and Supplementary Protectors

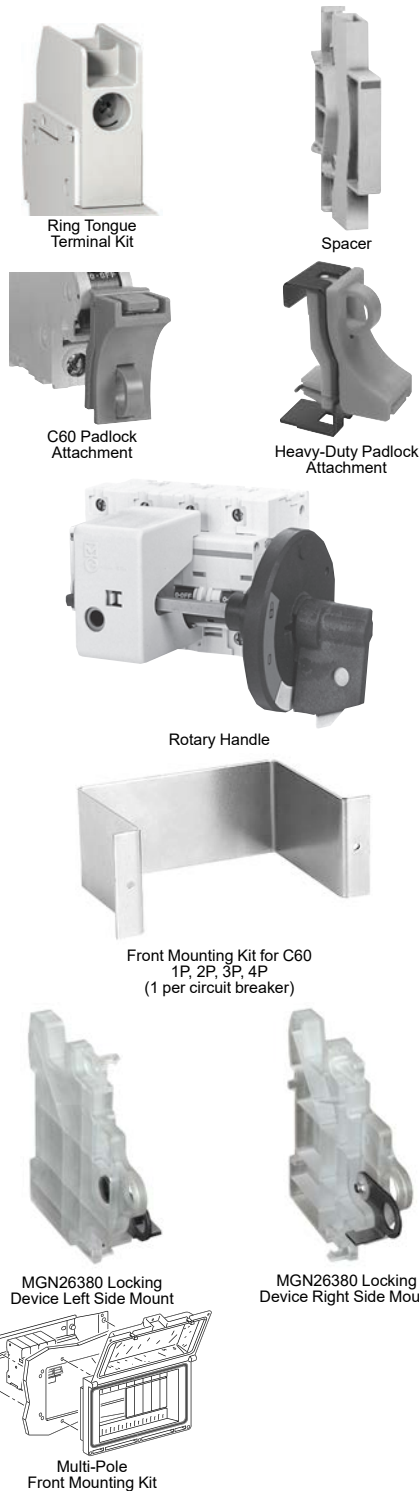

**Possible Combinations**  
Mounted to the left of the circuit breaker with a maximum width of 54 mm.

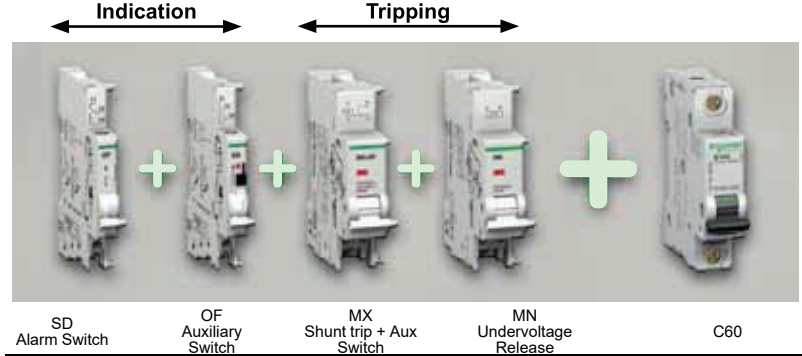

**Table 7.43: Multi 9 C60 Electrical Accessories**

Descriptions	Control Voltage		Width in 9 mm Modules	C60 UL/IEC Cat. No.
	Vac	Vdc		
OF Auxiliary Switch (1a1b)	12–277	12–125	1	M9A26924
SD Alarm Switch (1a1b)	12–277	12–125	1	M9A26927
MX Shunt Trip + OF Auxiliary Switch (1a1b)	24	24	2	M9A26948
	48	48	2	M9A26947
	110–240–277	125	2	M9A26946
MN Undervoltage Release	24	24	2	M9A27108
	48	48	2	M9A26961
	120	—	2	M9A27107
	240	—	2	M9A26960
Multi-9 GFP UL 1053 Listed Ground Fault Protectors	120 to 480Y/277 Vac; 30, 100, and 300 mA; 2P and 4Ps. See Multi 9 GFP Ground Fault Protectors, page 7-26 or Catalog LVCATM9OEM_EN			

**Table 7.44: Multi 9 C60 Mechanical Accessories**

Descriptions	C60 Cat. No.
Ring tongue terminal kit for UL1077 C60	M9A17400
Spacer for DIN rail, Not UL Recognized	27062
Padlock Attachment (1 per for 1P, 2P, 3P or 4P)	26970
Heavy-duty Padlock Attachment for C60, Locks OFF only	M9PAF
Padlocking Device Left Side Mount, Locks OFF only [1]	MGN26380
Padlocking Device Right Side Mount, Locks OFF only [2]	MGN26381
Front Mounting Kit	1P
	2P
	3P
	4P
Terminal Screw Shield (Not UL Recognized)	26981
Terminal cover (Not UL Recognized)	1P
	2P
	3P
	4P
Rotary Handle for C60 (Non UL Recognized)	27046
Operating Subassembly	27047
Door Interlock Handle	27048
Fixed Handle (Front or Lateral)	27048
<b>Multi-pole Front Mounting Kit</b>	
Rail Support (20 of 9 mm modules)	14211
Hinged Transparent Cover	14210

[1] Left-side mounted padlocking device cannot be used in conjunction with accessories SD, OF, MX or MN. Use right-side mounted padlocking device when accessories are required.  
[2] Right-side mounted padlocking device cannot be used in conjunction with VIGI module. Use left-side mounted padlocking device when VIGI Module is required.

**The PowerPact Advantage**

- **Proven Performance:** Industry-leading circuit breaker innovation and protection for heavy-duty commercial and industrial applications.
- **Smart:** Integrated metering options provide a cost-effective solution to reduce energy consumption, optimize energy costs, and improve energy availability for your facilities.
- **Flexible:** Full range of thermal-magnetic and electronic trip molded case circuit breakers from 15 A to 3000 A, delivering the ratings, configurations, and operators for your unique applications.
- **Simple:** Common catalog numbers, standardized ratings, and a full range of field-installable accessories make product selection, installation and maintenance easier than ever.
- **Common Design Features:** Mounting holes, door trim, and handle accessories

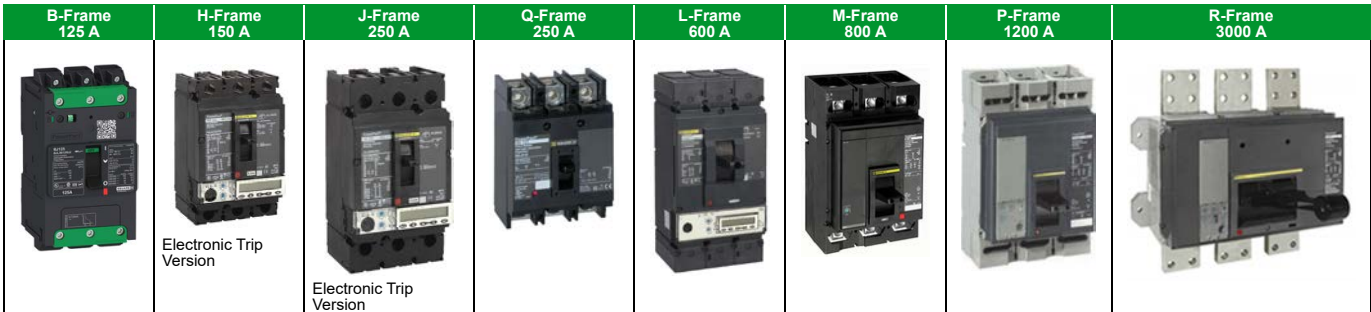

**Table 7.45: PowerPact Interrupting Ratings**

Voltage	Interrupting Rating						
	B	D	G	J	K	L	R
240 Vac	10 kA	25 kA	65 kA	100 kA	65 kA [1]	125 kA	200 kA
480 Vac		18 kA	35 kA	65 kA	65 kA [2]	100 kA	200 kA
600 Vac		14 kA	18 kA	25 kA	65 kA [2]	50 kA [3]	100 kA

**Table 7.46: Common Catalog Numbering System**

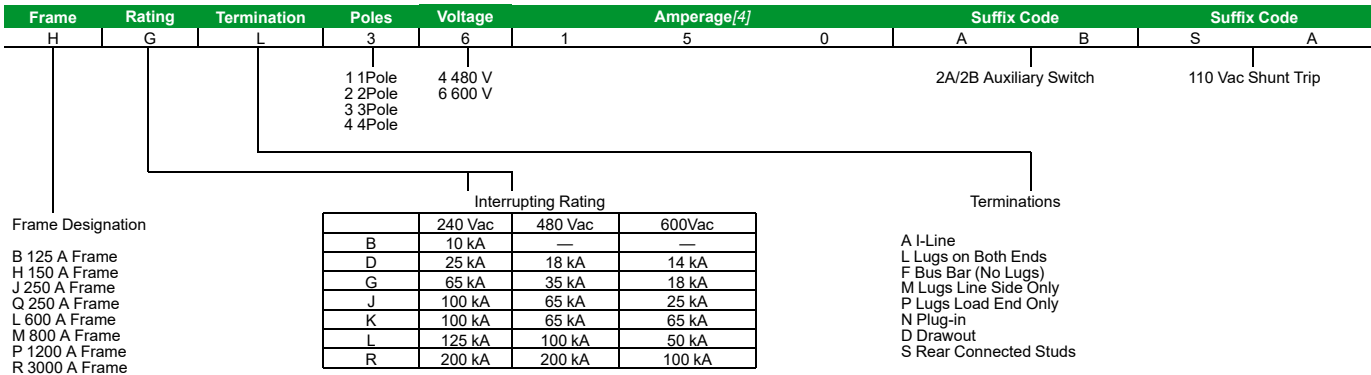

**Description**

- B-Frame Circuit Breakers, page 7-31
- H- and J-Frame Circuit Breakers, page 7-32
- Q-Frame Circuit Breakers, page 7-36
- L-Frame Circuit Breakers, page 7-37
- P-Frame Circuit Breakers, page 7-39
- R-Frame Circuit Breakers, page 7-40
- PowerPact™ H- and J-Frame Electronic Motor Circuit Protectors, page 7-42
- Motor Circuit Protectors and Motor Protector Circuit Breakers, page 7-45
- Automatic Switches, page 7-49
- 500 Vdc Circuit Breakers, page 7-50
- Mission Critical Circuit Breakers, page 7-52
- PowerPact™ Circuit Breaker Accessories, page 7-54
- Motor Operators and Rotary Handles, page 7-55
- Locks, Installation Accessories, and Rear Connections, page 7-57
- Mechanical Lugs, page 7-57
- Compression Lugs and Power Distribution Connectors (PDC), page 7-60
- Terminal Nuts, Terminal Pads, Terminal Shields and Accessories, page 7-62
- Plug-In and Drawout Mountings, page 7-63
- Micrologic™ Electronic Trip Units, page 7-64
- Micrologic™ Trip Unit Accessories, page 7-68

[1] B-Frame K interrupting rating is 100 kA at 240 Vac  
[2] P-frame K interrupting is 50 kA at 480 and 600 Vac.  
[3] P-frame L interrupting is 25 kA at 600 Vac.

[4] For amperage of M-, P- or R-frame circuit breakers, add a zero to the three amperage digits; for example, 120 = 1200 A.



**PowerPact B-Frame Circuit Breakers**



B-Frame Thermal-Magnetic Trip Unit

**Table 7.47: PowerPact B-Frame 125 A Thermal-Magnetic Circuit Breakers (600Y/347 Vac) with EverLink Lugs**

Current Rating @ 40° C	Interrupting Rating													
	D				G				J				K	
	1 Pole 347 Vac	2 Pole 600Y/347 Vac	3 Pole 600Y/347 Vac	4 Pole 600Y/347 Vac	1 Pole 347 Vac	2 Pole 600Y/347 Vac	3 Pole 600Y/347 Vac	4 Pole 600Y/347 Vac	1 Pole 347 Vac	2 Pole 600Y/347 Vac	3 Pole 600Y/347 Vac	4 Pole 600Y/347 Vac	1 Pole 347 Vac	2 Pole 600Y/347 Vac
15 A	BDL16015	BDL26015	BDL36015	BDL46015	BGL16015	BGL26015	BGL36015	BGL46015	BJL16015	BJL26015	BJL36015	BJL46015	BKL16015	BKL26015
20 A	BDL16020	BDL26020	BDL36020	BDL46020	BGL16020	BGL26020	BGL36020	BGL46020	BJL16020	BJL26020	BJL36020	BJL46020	BKL16020	BKL26020
25 A	BDL16025	BDL26025	BDL36025	BDL46025	BGL16025	BGL26025	BGL36025	BGL46025	BJL16025	BJL26025	BJL36025	BJL46025	BKL16025	BKL26025
30 A	BDL16030	BDL26030	BDL36030	BDL46030	BGL16030	BGL26030	BGL36030	BGL46030	BJL16030	BJL26030	BJL36030	BJL46030	BKL16030	BKL26030
35 A	BDL16035	BDL26035	BDL36035	BDL46035	BGL16035	BGL26035	BGL36035	BGL46035	BJL16035	BJL26035	BJL36035	BJL46035	—	—
40 A	BDL16040	BDL26040	BDL36040	BDL46040	BGL16040	BGL26040	BGL36040	BGL46040	BJL16040	BJL26040	BJL36040	BJL46040	—	—
45 A	BDL16045	BDL26045	BDL36045	BDL46045	BGL16045	BGL26045	BGL36045	BGL46045	BJL16045	BJL26045	BJL36045	BJL46045	—	—
50 A	BDL16050	BDL26050	BDL36050	BDL46050	BGL16050	BGL26050	BGL36050	BGL46050	BJL16050	BJL26050	BJL36050	BJL46050	—	—
60 A	BDL16060	BDL26060	BDL36060	BDL46060	BGL16060	BGL26060	BGL36060	BGL46060	BJL16060	BJL26060	BJL36060	BJL46060	—	—
70 A	BDL16070	BDL26070	BDL36070	BDL46070	BGL16070	BGL26070	BGL36070	BGL46070	BJL16070	BJL26070	BJL36070	BJL46070	—	—
80 A	BDL16080	BDL26080	BDL36080	BDL46080	BGL16080	BGL26080	BGL36080	BGL46080	BJL16080	BJL26080	BJL36080	BJL46080	—	—
90 A	BDL16090	BDL26090	BDL36090	BDL46090	BGL16090	BGL26090	BGL36090	BGL46090	BJL16090	BJL26090	BJL36090	BJL46090	—	—
100 A	BDL16100	BDL26100	BDL36100	BDL46100	BGL16100	BGL26100	BGL36100	BGL46100	BJL16100	BJL26100	BJL36100	BJL46100	—	—
110 A	BDL16110	BDL26110	BDL36110	BDL46110	BGL16110	BGL26110	BGL36110	BGL46110	BJL16110	BJL26110	BJL36110	BJL46110	—	—
125 A	BDL16125	BDL26125	BDL36125	BDL46125	BGL16125	BGL26125	BGL36125	BGL46125	BJL16125	BJL26125	BJL36125	BJL46125	—	—

**Table 7.48: B-Frame Termination Options**

Termination Letter	
A = I-Line (See Section 9)	B D L 3 6 1 0 0
F = No Lugs (includes terminal nut kit on both ends)	For factory-installed termination, place termination letter in the third block of the circuit breaker catalog number.
L = EverLink Lugs both ends	
M = Lugs ON end Terminal Nut Kit OFF end	
P = Lugs OFF end Terminal Nut Kit ON end	

**Table 7.49: B-Frame Interrupting Ratings**

Voltage	Interrupting Rating			
	D	G	J	K
240 Vac	25 kA	65 kA	100 kA	100 kA
480/277 Vac	18 kA	35 kA	65 kA	65 kA
480 Vac	18 kA	35 kA	65 kA	65 kA
600Y/347 Vac	14 kA	18 kA	25 kA	65 kA

**Table 7.50: B-Frame Lug Options**

Lug Option Suffix	
No Suffix = EverLink Lugs both ends	B D L 3 6 1 0 0 LU
LU = EverLink Lug with Control Wire Terminal ON end; EverLink Lug OFF end	For factory-installed lug option, place suffix after the amperage in the circuit breaker catalog number.
LV = EverLink Lug ON end; EverLink Lug with Control Wire Terminal OFF end	
LW = EverLink Lug with Control Wire Terminal both ends	
LC = Copper Mechanical Lugs both ends	
LH = Aluminum Mechanical Lugs both ends	

**Table 7.51: PowerPact B-Frame 125 A Magnetic Trip Values**

Current Rating @ 40° C	Fixed AC Magnetic Trip	
	Hold	Trip
15 A	400 A	600 A
20 A	400 A	600 A
25 A	400 A	600 A
30 A	400 A	600 A
35 A	400 A	600 A
40 A	400 A	600 A
45 A	400 A	600 A
50 A	480 A	720 A
60 A	640 A	960 A
70 A	640 A	960 A
80 A	800 A	1200 A
90 A	1000 A	1500 A
100 A	1000 A	1500 A
110 A	1000 A	1500 A
125 A	1000 A	1500 A

Accessories see [page 7-54](#)  
Optional Lugs see [page 7-59](#)  
Dimensions see [page 7-75](#)

PowerPact H- and J-Frame Circuit Breakers



HD and HG 2P  
Thermal-Magnetic Trip Unit  
(2P HJ, HL in 3P module)

H-Frame  
Thermal-Magnetic Trip Unit

Table 7.52: H-Frame 150 A Thermal-Magnetic UL Current-Limiting [5] Circuit Breakers (600 Vac, 250 Vdc) [6] With Factory Sealed Trip Unit Suitable for Reverse Connection [7]

Current Rating @ 40° C	Fixed AC Magnetic Trip		Interrupting Rating							
			D		G		J [6]		L [6]	
	Hold	Trip	Standard (80% Rated)	100% Rated	Standard (80% Rated)	100% Rated	Standard (80% Rated)	100% Rated	Standard (80% Rated)	100% Rated
H-Frame, 150A 2P, 600 Vac 50/60 Hz, 250 Vdc [8]										
15 A	350 A	750 A	HDL26015	HDL26015C	HGL26015	HGL26015C	HJL26015	HJL26015C	HLL26015	HLL26015C
20 A	350 A	750 A	HDL26020	HDL26020C	HGL26020	HGL26020C	HJL26020	HJL26020C	HLL26020	HLL26020C
25 A	350 A	750 A	HDL26025	HDL26025C	HGL26025	HGL26025C	HJL26025	HJL26025C	HLL26025	HLL26025C
30 A	350 A	750 A	HDL26030	HDL26030C	HGL26030	HGL26030C	HJL26030	HJL26030C	HLL26030	HLL26030C
35 A	400 A	850 A	HDL26035	HDL26035C	HGL26035	HGL26035C	HJL26035	HJL26035C	HLL26035	HLL26035C
40 A	400 A	850 A	HDL26040	HDL26040C	HGL26040	HGL26040C	HJL26040	HJL26040C	HLL26040	HLL26040C
45 A	400 A	850 A	HDL26045	HDL26045C	HGL26045	HGL26045C	HJL26045	HJL26045C	HLL26045	HLL26045C
50 A	400 A	850 A	HDL26050	HDL26050C	HGL26050	HGL26050C	HJL26050	HJL26050C	HLL26050	HLL26050C
60 A	800 A	1450 A	HDL26060	HDL26060C	HGL26060	HGL26060C	HJL26060	HJL26060C	HLL26060	HLL26060C
70 A	800 A	1450 A	HDL26070	HDL26070C	HGL26070	HGL26070C	HJL26070	HJL26070C	HLL26070	HLL26070C
80 A	800 A	1450 A	HDL26080	HDL26080C	HGL26080	HGL26080C	HJL26080	HJL26080C	HLL26080	HLL26080C
90 A	800 A	1450 A	HDL26090	HDL26090C	HGL26090	HGL26090C	HJL26090	HJL26090C	HLL26090	HLL26090C
100 A	800 A	1700 A	HDL26100	HDL26100C	HGL26100	HGL26100C	HJL26100	HJL26100C	HLL26100	HLL26100C
110 A	900 A	1700 A	HDL26110	HDL26110C	HGL26110	HGL26110C	HJL26110	HJL26110C	HLL26110	HLL26110C
125 A	900 A	1700 A	HDL26125	HDL26125C	HGL26125	HGL26125C	HJL26125	HJL26125C	HLL26125	HLL26125C
150 A	900 A	1700 A	HDL26150	HDL26150C	HGL26150	HGL26150C	HJL26150	HJL26150C	HLL26150	HLL26150C
H-Frame 150A 3P, 600 Vac 50/60 Hz, 250 Vdc										
15 A	350 A	750 A	HDL36015	HDL36015C	HGL36015	HGL36015C	HJL36015	HJL36015C	HLL36015	HLL36015C
20 A	350 A	750 A	HDL36020	HDL36020C	HGL36020	HGL36020C	HJL36020	HJL36020C	HLL36020	HLL36020C
25 A	350 A	750 A	HDL36025	HDL36025C	HGL36025	HGL36025C	HJL36025	HJL36025C	HLL36025	HLL36025C
30 A	350 A	750 A	HDL36030	HDL36030C	HGL36030	HGL36030C	HJL36030	HJL36030C	HLL36030	HLL36030C
35 A	400 A	850 A	HDL36035	HDL36035C	HGL36035	HGL36035C	HJL36035	HJL36035C	HLL36035	HLL36035C
40 A	400 A	850 A	HDL36040	HDL36040C	HGL36040	HGL36040C	HJL36040	HJL36040C	HLL36040	HLL36040C
45 A	400 A	850 A	HDL36045	HDL36045C	HGL36045	HGL36045C	HJL36045	HJL36045C	HLL36045	HLL36045C
50 A	400 A	850 A	HDL36050	HDL36050C	HGL36050	HGL36050C	HJL36050	HJL36050C	HLL36050	HLL36050C
60 A	800 A	1450 A	HDL36060	HDL36060C	HGL36060	HGL36060C	HJL36060	HJL36060C	HLL36060	HLL36060C
70 A	800 A	1450 A	HDL36070	HDL36070C	HGL36070	HGL36070C	HJL36070	HJL36070C	HLL36070	HLL36070C
80 A	800 A	1450 A	HDL36080	HDL36080C	HGL36080	HGL36080C	HJL36080	HJL36080C	HLL36080	HLL36080C
90 A	800 A	1450 A	HDL36090	HDL36090C	HGL36090	HGL36090C	HJL36090	HJL36090C	HLL36090	HLL36090C
100 A	800 A	1700 A	HDL36100	HDL36100C	HGL36100	HGL36100C	HJL36100	HJL36100C	HLL36100	HLL36100C
110 A	900 A	1700 A	HDL36110	HDL36110C	HGL36110	HGL36110C	HJL36110	HJL36110C	HLL36110	HLL36110C
125 A	900 A	1700 A	HDL36125	HDL36125C	HGL36125	HGL36125C	HJL36125	HJL36125C	HLL36125	HLL36125C
150 A	900 A	1700 A	HDL36150	HDL36150C	HGL36150	HGL36150C	HJL36150	HJL36150C	HLL36150	HLL36150C

[5] Circuit breakers with J and L interrupting ratings are UL certified as current limiting.  
 [6] Standard lug kit: AL150HD. Terminal wire range: 14–3/0 AWG Al or Cu.  
 [7] See Supplemental Digest Section 3 for circuit breakers with field interchangeable trip units.  
 [8] HD and HG circuit breakers are true two-pole construction.

**Table 7.53: J-Frame 250 A Thermal-Magnetic UL Current-Limiting [9] Circuit Breakers (600 Vac, 250 Vdc) With Factory Sealed Trip Unit Suitable for Reverse Connection [10]**

Current Rating @ 40°C	Adjustable AC Magnetic Trip		Interrupting Rating									
			D		G		J [9]		L [9]		R [9]	
	Low	High	Standard (80% Rated)	100% Rated	Standard (80% Rated)	100% Rated	Standard (80% Rated)	100% Rated	Standard (80% Rated)	100% Rated	Standard (80% Rated)	100% Rated
J-Frame 250A 2P, 600 Vac 50/60 Hz, 250 Vdc												
150 A [11]	750 A	1500 A	JDL26150	JDL26150C	JGL26150	JGL26150C	JLL26150	JLL26150C	JLL26150	JLL26150C	—	—
175 A [11]	875 A	1750 A	JDL26175	JDL26175C	JGL26175	JGL26175C	JLL26175	JLL26175C	JLL26175	JLL26175C	—	—
200 A [12]	1000 A	2000 A	JDL26200	JDL26200C	JGL26200	JGL26200C	JLL26200	JLL26200C	JLL26200	JLL26200C	—	—
225 A [12]	1125 A	2250 A	JDL26225	JDL26225C	JGL26225	JGL26225C	JLL26225	JLL26225C	JLL26225	JLL26225C	—	—
250 A [12]	1250 A	2500 A	JDL26250	JDL26250C	JGL26250	JGL26250C	JLL26250	JLL26250C	JLL26250	JLL26250C	—	—
J-Frame 250A 3P, 600 Vac 50/60 Hz, 250 Vdc												
150 A [11]	750 A	1500 A	JDL36150	JDL36150C	JGL36150	JGL36150C	JJL36150	JJL36150C	JLL36150	JLL36150C	JRL36150	JRL36150C
175 A [11]	875 A	1750 A	JDL36175	JDL36175C	JGL36175	JGL36175C	JJL36175	JJL36175C	JLL36175	JLL36175C	JRL36175	JRL36175C
200 A [12]	1000 A	2000 A	JDL36200	JDL36200C	JGL36200	JGL36200C	JJL36200	JJL36200C	JLL36200	JLL36200C	JRL36200	JRL36200C
225 A [12]	1125 A	2250 A	JDL36225	JDL36225C	JGL36225	JGL36225C	JJL36225	JJL36225C	JLL36225	JLL36225C	JRL36225	JRL36225C
250 A [12]	1250 A	2500 A	JDL36250	JDL36250C	JGL36250	JGL36250C	JJL36250	JJL36250C	JLL36250	JLL36250C	JRL36250	JRL36250C



Plug-in



Drawout



Rear Connected

**Table 7.54: H- and J-Frame Interrupting Ratings**

Voltage	Interrupting Rating				
	D	G	J	L	R
240 Vac	25 kA	65 kA	100 kA	125 kA	200 kA
480 Vac	18 kA	35 kA	65 kA	100 kA	200 kA
600 Vac	14 kA	18 kA	25 kA	50 kA	100 kA

**Table 7.55: H- and J-Frame Termination Options**

Termination Letter	
A = I-Line (See Section 9)	H G L 3 6 1 0 0
F = No Lugs (includes terminal nut kit on both ends)	For factory-installed termination, place termination letter in the third block of the circuit breaker catalog number.
L = Lugs both ends	
M = Lugs ON end Terminal Nut Kit OFF end	
P = Lugs OFF end Terminal Nut Kit ON end	
N = Plug-in	
D = Drawout	
S = Rear Connected	

Accessories see page 7-54  
Optional Lugs see page 7-59  
Dimensions see page 7-75  
Enclosures see page 7-76

[9] Circuit breakers with J, L, and R interrupting ratings are UL certified as current limiting.  
[10] See Supplemental Digest Section 3 for circuit breakers with field interchangeable trip units.  
[11] Standard lug kit: AL175JD. Terminal wire range: 4–4/0 AWG Al or Cu.  
[12] Standard lug kit: AL250JD. Terminal wire range: 3/0 AWG–350 kcmil Al or Cu.

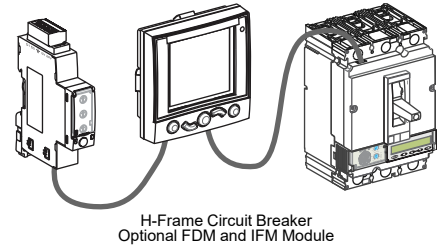

**Table 7.56: H-Frame 150 A and J-Frame 250 A Electronic Trip UL Current-Limiting [13] Standard (80% Rated) Circuit Breakers (600 Vac) With Factory Sealed Trip Unit [14] Suitable for Reverse Connection [15]**

Electronic Trip Unit			Sensor Rating	Interrupting Rating (80% Rated)				
Type	Function	Trip Unit		D	G	J [13]	L [13]	R [13]
600 Vac, 50/60 Hz, 3P								
Micrologic Standard	LI	3.2 [16]	60 A [17]	HDL36060U31X	HGL36060U31X	HJL36060U31X	HLL36060U31X	HRL36060U31X
			100 A [17]	HDL36100U31X	HGL36100U31X	HJL36100U31X	HLL36100U31X	HRL36100U31X
			150 A [17]	HDL36150U31X	HGL36150U31X	HJL36150U31X	HLL36150U31X	HRL36150U31X
			250 A [18]	JDL36250U31X	JGL36250U31X	JJL36250U31X	JLL36250U31X	JRL36250U31X
Micrologic Standard	LSI	3.2S [16] [19]	60 A [17]	HDL36060U33X	HGL36060U33X	HJL36060U33X	HLL36060U33X	HRL36060U33X
			100 A [17]	HDL36100U33X	HGL36100U33X	HJL36100U33X	HLL36100U33X	HRL36100U33X
			150 A [17]	HDL36150U33X	HGL36150U33X	HJL36150U33X	HLL36150U33X	HRL36150U33X
			250 A [18]	JDL36250U33X	JGL36250U33X	JJL36250U33X	JLL36250U33X	JRL36250U33X
Micrologic Ammeter	LSI	5.2A	60 A [17]	HDL36060U43X	HGL36060U43X	HJL36060U43X	HLL36060U43X	HRL36060U43X
			100 A [17]	HDL36100U43X	HGL36100U43X	HJL36100U43X	HLL36100U43X	HRL36100U43X
			150 A [17]	HDL36150U43X	HGL36150U43X	HJL36150U43X	HLL36150U43X	HRL36150U43X
			250 A [18]	JDL36250U43X	JGL36250U43X	JJL36250U43X	JLL36250U43X	JRL36250U43X
Micrologic Energy	LSI	5.2E	60 A [17]	HDL36060U53X	HGL36060U53X	HJL36060U53X	HLL36060U53X	HRL36060U53X
			100 A [17]	HDL36100U53X	HGL36100U53X	HJL36100U53X	HLL36100U53X	HRL36100U53X
			150 A [17]	HDL36150U53X	HGL36150U53X	HJL36150U53X	HLL36150U53X	HRL36150U53X
			250 A [18]	JDL36250U53X	JGL36250U53X	JJL36250U53X	JLL36250U53X	JRL36250U53X
Micrologic Ammeter	LSIG	6.2A [20]	60 A [17]	HDL36060U44X	HGL36060U44X	HJL36060U44X	HLL36060U44X	HRL36060U44X
			100 A [17]	HDL36100U44X	HGL36100U44X	HJL36100U44X	HLL36100U44X	HRL36100U44X
			150 A [17]	HDL36150U44X	HGL36150U44X	HJL36150U44X	HLL36150U44X	HRL36150U44X
			250 A [18]	JDL36250U44X	JGL36250U44X	JJL36250U44X	JLL36250U44X	JRL36250U44X
Micrologic Energy	LSIG	6.2E	60 A [17]	HDL36060U54X	HGL36060U54X	HJL36060U54X	HLL36060U54X	HRL36060U54X
			100 A [17]	HDL36100U54X	HGL36100U54X	HJL36100U54X	HLL36100U54X	HRL36100U54X
			150 A [17]	HDL36150U54X	HGL36150U54X	HJL36150U54X	HLL36150U54X	HRL36150U54X
			250 A [18]	JDL36250U54X	JGL36250U54X	JJL36250U54X	JLL36250U54X	JRL36250U54X

**Table 7.57: H-Frame 150 A and J-Frame 250 A Electronic Trip UL Current-Limiting [13] 100% Rated Circuit Breakers (600 Vac) With Factory Sealed Trip Unit [14] Suitable for Reverse Connection [15]**

Electronic Trip Unit			Sensor Rating	Interrupting Rating (100% Rated)				
Type	Function	Trip Unit		D	G	J [13]	L [13]	R [13]
600 Vac, 50/60 Hz, 3P								
Micrologic Standard	LI	3.2 [16]	60 A [17]	HDL36060CU31X	HGL36060CU31X	HJL36060CU31X	HLL36060CU31X	HRL36060CU31X
			100 A [17]	HDL36100CU31X	HGL36100CU31X	HJL36100CU31X	HLL36100CU31X	HRL36100CU31X
			150 A [17]	HDL36150CU31X	HGL36150CU31X	HJL36150CU31X	HLL36150CU31X	HRL36150CU31X
			250 A [18]	JDL36250CU31X	JGL36250CU31X	JJL36250CU31X	JLL36250CU31X	JRL36250CU31X
Micrologic Standard	LSI	3.2S [16] [19]	60 A [17]	HDL36060CU33X	HGL36060CU33X	HJL36060CU33X	HLL36060CU33X	HRL36060CU33X
			100 A [17]	HDL36100CU33X	HGL36100CU33X	HJL36100CU33X	HLL36100CU33X	HRL36100CU33X
			150 A [17]	HDL36150CU33X	HGL36150CU33X	HJL36150CU33X	HLL36150CU33X	HRL36150CU33X
			250 A [18]	JDL36250CU33X	JGL36250CU33X	JJL36250CU33X	JLL36250CU33X	JRL36250CU33X
Micrologic Ammeter	LSI	5.2A	60 A [17]	HDL36060CU43X	HGL36060CU43X	HJL36060CU43X	HLL36060CU43X	HRL36060CU43X
			100 A [17]	HDL36100CU43X	HGL36100CU43X	HJL36100CU43X	HLL36100CU43X	HRL36100CU43X
			150 A [17]	HDL36150CU43X	HGL36150CU43X	HJL36150CU43X	HLL36150CU43X	HRL36150CU43X
			250 A [18]	JDL36250CU43X	JGL36250CU43X	JJL36250CU43X	JLL36250CU43X	JRL36250CU43X
Micrologic Energy	LSI	5.2E	60 A [17]	HDL36060CU53X	HGL36060CU53X	HJL36060CU53X	HLL36060CU53X	HRL36060CU53X
			100 A [17]	HDL36100CU53X	HGL36100CU53X	HJL36100CU53X	HLL36100CU53X	HRL36100CU53X
			150 A [17]	HDL36150CU53X	HGL36150CU53X	HJL36150CU53X	HLL36150CU53X	HRL36150CU53X
			250 A [18]	JDL36250CU53X	JGL36250CU53X	JJL36250CU53X	JLL36250CU53X	JRL36250CU53X
Micrologic Ammeter	LSIG	6.2A [20]	60 A [17]	HDL36060CU44X	HGL36060CU44X	HJL36060CU44X	HLL36060CU44X	HRL36060CU44X
			100 A [17]	HDL36100CU44X	HGL36100CU44X	HJL36100CU44X	HLL36100CU44X	HRL36100CU44X
			150 A [17]	HDL36150CU44X	HGL36150CU44X	HJL36150CU44X	HLL36150CU44X	HRL36150CU44X
			250 A [18]	JDL36250CU44X	JGL36250CU44X	JJL36250CU44X	JLL36250CU44X	JRL36250CU44X
Micrologic Energy	LSIG	6.2E	60 A [17]	HDL36060CU54X	HGL36060CU54X	HJL36060CU54X	HLL36060CU54X	HRL36060CU54X
			100 A [17]	HDL36100CU54X	HGL36100CU54X	HJL36100CU54X	HLL36100CU54X	HRL36100CU54X
			150 A [17]	HDL36150CU54X	HGL36150CU54X	HJL36150CU54X	HLL36150CU54X	HRL36150CU54X
			250 A [18]	JDL36250CU54X	JGL36250CU54X	JJL36250CU54X	JLL36250CU54X	JRL36250CU54X

[13] Circuit breakers with J, L, and R interrupting ratings are UL certified as current limiting.  
 [14] See Supplemental Digest Section 3 for circuit breakers with field interchangeable trip units.  
 [15] For applications requiring communications see page 7-68.  
 [16] 3P circuit breakers with this trip unit can be used for 2P applications.  
 [17] Standard lug kit: AL150HD. Terminal wire range: 14–3/0 AWG Al or Cu.  
 [18] Standard lug kit: AL250JD. Terminal wire range: 3/0 AWG–350 kcmil Al or Cu.  
 [19] Fixed ST and LT delays.  
 [20] 3P circuit breakers with this trip unit can be used for 2P applications in order to have ground fault protection. Additional metering capabilities will not work properly on the unconnected phase.

**Table 7.58: H- and J-Frame Termination Options**

Termination Letter	
A - I-Line (See Section 9)	H D L 3 6 0 1 5 T For factory-installed termination, place termination letter in the third block of the circuit breaker catalog number.
F = No Lugs (includes terminal nut kit on both ends)	
L = Lugs both ends	
M = Lugs ON end Terminal Nut Kit OFF end	
P = Lugs OFF end Terminal Nut Kit ON end	
N = Plug-in	
D = Drawout	
S = Rear Connected	

**Table 7.59: H- and J-Frame Interrupting Ratings**

Voltage	Interrupting Rating				
	D	G	J	L	R
240 Vac	25 kA	65 kA	100 kA	125 kA	200 kA
480 Vac	18 kA	35 kA	65 kA	100 kA	200 kA
600 Vac	14 kA	18 kA	25 kA	50 kA	100 kA

Accessories see [page 7-54](#)  
Optional Lugs see [page 7-59](#)  
Dimensions see [page 7-75](#)  
Enclosures see [page 7-76](#)

**Q-Frame Molded Case Circuit Breakers**

**Table 7.60: PowerPact Q-Frame 250 A Thermal-Magnetic Circuit Breaker (240 Vac)**

[21]



QBL 2P  
70–250



QBL 3P  
70–250 A

Ampere Rating	Fixed AC Magnetic Trip		Interrupting Rating				Terminal Wire Range
	Hold	Trip	B	D	G	J	
<b>2P, 240 Vac</b>							
70 A	1000 A	1800 A	QBL22070	QDL22070	QGL22070	QJL22070	#4 AWG - 300 kcmil Al/Cu
80 A	1000 A	1800 A	QBL22080	QDL22080	QGL22080	QJL22080	
90 A	1000 A	1800 A	QBL22090	QDL22090	QGL22090	QJL22090	
100 A	1200 A	2400 A	QBL22100	QDL22100	QGL22100	QJL22100	
110 A	1200 A	2400 A	QBL22110	QDL22110	QGL22110	QJL22110	
125 A	1200 A	2400 A	QBL22125	QDL22125	QGL22125	QJL22125	
150 A	1200 A	2400 A	QBL22150	QDL22150	QGL22150	QJL22150	
175 A	1200 A	2400 A	QBL22175	QDL22175	QGL22175	QJL22175	
200 A	1200 A	2400 A	QBL22200	QDL22200	QGL22200	QJL22200	
225 A	1200 A	2400 A	QBL22225	QDL22225	QGL22225	QJL22225	
250 A [22]	1200 A	2400 A	QBL22250	QDL22250	QGL22250	QJL22250	
<b>3P, 240 Vac</b>							
70 A	1000 A	1800 A	QBL32070	QDL32070	QGL32070	QJL32070	#4 AWG - 300 kcmil Al/Cu
80 A	1000 A	1800 A	QBL32080	QDL32080	QGL32080	QJL32080	
90 A	1000 A	1800 A	QBL32090	QDL32090	QGL32090	QJL32090	
100 A	1200 A	2400 A	QBL32100	QDL32100	QGL32100	QJL32100	
110 A	1200 A	2400 A	QBL32110	QDL32110	QGL32110	QJL32110	
125 A	1200 A	2400 A	QBL32125	QDL32125	QGL32125	QJL32125	
150 A	1200 A	2400 A	QBL32150	QDL32150	QGL32150	QJL32150	
175 A	1200 A	2400 A	QBL32175	QDL32175	QGL32175	QJL32175	
200 A	1200 A	2400 A	QBL32200	QDL32200	QGL32200	QJL32200	
225 A	1200 A	2400 A	QBL32225	QDL32225	QGL32225	QJL32225	
250 A [22]	1200 A	2400 A	QBL32250	QDL32250	QGL32250	QJL32250	

**Table 7.61: Q-Frame Termination Options**

Termination Letter	
A = I-Line (See Section 9)	Q G L 3 2 2 0 0 For factory-installed termination, place termination letter in the third block of the circuit breaker catalog number.
E = Bolt-on I-Line (See Section 9)	
F = No lugs	
L = Lugs both ends	
M = Lugs ON end, studs on OFF end	
P = Lugs OFF end, studs on ON end	

**Table 7.62: Q-Frame Interrupting Ratings**

Voltage	Interrupting Rating			
	B	D	G	J
240 Vac [23]	10 kA	25 kA	65 kA	100 kA [24]

Dimension see page 7-75  
Enclosures see page 7-76

[21] Replacement lugs and electrical accessories are not available for PowerPact Q-frame circuit breakers.  
 [22] 250 A lugs are suitable for copper conductors only.  
 [23] Q-frame circuit breakers are 240 Vac only.  
 [24] 3P QJ circuit breakers are rated at 208Y/120 Vac only.

**PowerPact L-Frame Molded Case Circuit Breakers**

**Table 7.63: L-Frame 600 A Standard (80% Rated) UL Current-Limiting [25] Circuit Breakers with Lugs and Factory-Sealed Electronic Trip Units Suitable for Reverse Connection [26][27]**

Electronic Trip Unit			Sensor Rating	Interrupting Rating (80% Rated)					Terminal
Type	Function	Trip Unit		D	G	J [25]	L [25]	R [25]	
600 Vac, 50/60 Hz, 3P									
Micrologic Standard	LI	3.3 [28]	250 A	LDL36250U31X	LGL36250U31X	LJL36250U31X	LLL36250U31X	LRL36250U31X	AL400L61K3 [29]
			400 A	LDL36400U31X	LGL36400U31X	LJL36400U31X	LLL36400U31X	LRL36400U31X	AL600LS52K3 [30]
			600 A	LDL36600U31X	LGL36600U31X	LJL36600U31X	LLL36600U31X	LRL36600U31X	AL400L61K3 [29]
Micrologic Standard	LSI	3.3S [28] [31]	250 A	LDL36250U33X	LGL36250U33X	LJL36250U33X	LLL36250U33X	LRL36250U33X	AL400L61K3 [29]
			400 A	LDL36400U33X	LGL36400U33X	LJL36400U33X	LLL36400U33X	LRL36400U33X	AL600LS52K3 [30]
			600 A	LDL36600U33X	LGL36600U33X	LJL36600U33X	LLL36600U33X	LRL36600U33X	AL600LS52K3 [30]
Micrologic Ammeter	LSI	5.3A	400 A	LDL36400U43X	LGL36400U43X	LJL36400U43X	LLL36400U43X	LRL36400U43X	AL600LS52K3 [30]
			600 A	LDL36600U43X	LGL36600U43X	LJL36600U43X	LLL36600U43X	LRL36600U43X	
Micrologic Energy	LSI	5.3E	400 A	LDL36400U53X	LGL36400U53X	LJL36400U53X	LLL36400U53X	LRL36400U53X	
			600 A	LDL36600U53X	LGL36600U53X	LJL36600U53X	LLL36600U53X	LRL36600U53X	
Micrologic Ammeter	LSIG	6.3A	400 A	LDL36400U44X	LGL36400U44X	LJL36400U44X	LLL36400U44X	LRL36400U44X	
			600 A	LDL36600U44X	LGL36600U44X	LJL36600U44X	LLL36600U44X	LRL36600U44X	
Micrologic Energy	LSIG	6.3E [32]	400 A	LDL36400U54X	LGL36400U54X	LJL36400U54X	LLL36400U54X	LRL36400U54X	
			600 A	LDL36600U54X	LGL36600U54X	LJL36600U54X	LLL36600U54X	LRL36600U54X	
600 Vac, 50/60 Hz, 4P									
Micrologic Standard	LI	3.3	250 A	LDL46250U31X	LGL46250U31X	LJL46250U31X	LLL46250U31X	LRL46250U31X	
			400 A	LDL46400U31X	LGL46400U31X	LJL46400U31X	LLL46400U31X	LRL46400U31X	AL600LS52K4 [30]
			600 A	LDL46600U31X	LGL46600U31X	LJL46600U31X	LLL46600U31X	LRL46600U31X	AL400L61K4 [29]
Micrologic Standard	LSI	3.3S [31]	250 A	LDL46250U33X	LGL46250U33X	LJL46250U33X	LLL46250U33X	LRL46250U33X	AL400L61K4 [29]
			400 A	LDL46400U33X	LGL46400U33X	LJL46400U33X	LLL46400U33X	LRL46400U33X	AL600LS52K4 [30]
			600 A	LDL46600U33X	LGL46600U33X	LJL46600U33X	LLL46600U33X	LRL46600U33X	AL600LS52K4 [30]
Micrologic Ammeter	LSI	5.3A	400 A	LDL46400U43X	LGL46400U43X	LJL46400U43X	LLL46400U43X	LRL46400U43X	AL600LS52K4 [30]
			600 A	LDL46600U43X	LGL46600U43X	LJL46600U43X	LLL46600U43X	LRL46600U43X	
Micrologic Energy	LSI	5.3E	400 A	LDL46400U53X	LGL46400U53X	LJL46400U53X	LLL46400U53X	LRL46400U53X	
			600 A	LDL46600U53X	LGL46600U53X	LJL46600U53X	LLL46600U53X	LRL46600U53X	
Micrologic Ammeter	LSIG	6.3A	400 A	LDL46400U44X	LGL46400U44X	LJL46400U44X	LLL46400U44X	LRL46400U44X	
			600 A	LDL46600U44X	LGL46600U44X	LJL46600U44X	LLL46600U44X	LRL46600U44X	
Micrologic Energy	LSIG	6.3E	400 A	LDL46400U54X	LGL46400U54X	LJL46400U54X	LLL46400U54X	LRL46400U54X	
			600 A	LDL46600U54X	LGL46600U54X	LJL46600U54X	LLL46600U54X	LRL46600U54X	

**Table 7.64: L-Frame 600 A 100% Rated UL Current-Limiting [25] Circuit Breakers with Lugs and Factory-Sealed Electronic Trip Units Suitable for Reverse Connection [26][27]**

Electronic Trip Unit			Sensor Rating	Interrupting Rating (100% Rated)					Terminal	
Type	Function	Trip Unit		D	G	J [25]	L [25]	R [25]		
600 Vac, 50/60 Hz, 3P										
Micrologic Standard	LI	3.3 [28]	250 A	LDL36250CU31X	LGL36250CU31X	LJL36250CU31X	LLL36250CU31X	LRL36250CU31X	AL400L61K3 [29]	
			400 A	LDL36400CU31X	LGL36400CU31X	LJL36400CU31X	LLL36400CU31X	LRL36400CU31X	AL600LS52K3 [30]	
Micrologic Standard	LSI	3.3S [28] [31]	250 A	LDL36250CU33X	LGL36250CU33X	LJL36250CU33X	LLL36250CU33X	LRL36250CU33X	AL400L61K3 [29]	
			400 A	LDL36400CU33X	LGL36400CU33X	LJL36400CU33X	LLL36400CU33X	LRL36400CU33X	AL600LS52K3 [30]	
Micrologic Ammeter	LSI	5.3A	400 A	LDL36400CU43X	LGL36400CU43X	LJL36400CU43X	LLL36400CU43X	LRL36400CU43X	AL600LS52K3 [30]	
Micrologic Energy	LSI	5.3E	400 A	LDL36400CU53X	LGL36400CU53X	LJL36400CU53X	LLL36400CU53X	LRL36400CU53X		
Micrologic Ammeter	LSIG	6.3A	400 A	LDL36400CU44X	LGL36400CU44X	LJL36400CU44X	LLL36400CU44X	LRL36400CU44X		
Micrologic Energy	LSIG	6.3E [32]	400 A	LDL36400CU54X	LGL36400CU54X	LJL36400CU54X	LLL36400CU54X	LRL36400CU54X		
600 Vac, 50/60 Hz, 4P										
Micrologic Standard	LI	3.3	250 A	LDL46250CU31X	LGL46250CU31X	LJL46250CU31X	LLL46250CU31X	LRL46250CU31X		AL400L61K4 [29]
			400 A	LDL46400CU31X	LGL46400CU31X	LJL46400CU31X	LLL46400CU31X	LRL46400CU31X		AL600LS52K4 [30]
Micrologic Standard	LSI	3.3S	250 A	LDL46250CU33X	LGL46250CU33X	LJL46250CU33X	LLL46250CU33X	LRL46250CU33X		AL400L61K4 [29]
			400 A	LDL46400CU33X	LGL46400CU33X	LJL46400CU33X	LLL46400CU33X	LRL46400CU33X		AL600LS52K4 [30]
Micrologic Ammeter	LSI	5.3A	400 A	LDL46400CU43X	LGL46400CU43X	LJL46400CU43X	LLL46400CU43X	LRL46400CU43X		AL600LS52K4 [30]
Micrologic Energy	LSI	5.3E	400 A	LDL46400CU53X	LGL46400CU53X	LJL46400CU53X	LLL46400CU53X	LRL46400CU53X		
Micrologic Ammeter	LSIG	6.3A	400 A	LDL46400CU44X	LGL46400CU44X	LJL46400CU44X	LLL46400CU44X	LRL46400CU44X		
Micrologic Energy	LSIG	6.3E	400 A	LDL46400CU54X	LGL46400CU54X	LJL46400CU54X	LLL46400CU54X	LRL46400CU54X		



L-Frame Circuit Breaker

**Table 7.65: Termination Options**

Termination Letter	Termination Option
A	I-Line (See Section 9)
F	No lugs
L	Lugs both ends
M	Lugs ON end, terminal nut kit OFF end
P	Lugs OFF end, terminal nut kit ON end
N	Plug In
D	Drawout
S	Rear Connected

For factory-installed termination, place termination letter in the third block of the circuit breaker catalog number.  
Termination Letter  
L G L 3 6 6 0 0 U 4 4 X

[25] Circuit breakers with J, L, and R interrupting ratings are UL certified as current limiting.  
 [26] See Supplemental Digest Section 3 for circuit breakers with field interchangeable trip units.  
 [27] For applications requiring communications see page 7-68.  
 [28] 3P circuit breakers with this trip unit can be used for 2P applications.  
 [29] AL400L61K3 terminal wire ranges are (1) 2 AWG–600 kcmil Cu or (1) 2 AWG–500 kcmil Al.  
 [30] AL600LS52K3 terminal wire range is (2) 2/0 AWG–500 kcmil Al/Cu.  
 [31] Fixed ST and LT delays.  
 [32] 3P circuit breakers with this trip unit can be used for 2P applications in order to have ground fault protection. Additional metering capabilities will not work properly on the unconnected phase.

Accessories see page 7-54  
Optional Lugs see page 7-59  
Dimensions see page 7-75  
Enclosures see page 7-76



M-Frame Circuit Breaker

Table 7.66: Interrupting Ratings

Voltage	Interrupting Rating				
	D	G	J	L	R
240 Vac	25 kA	65 kA	100 kA	125 kA	200 kA
480 Vac	18 kA	35 kA	65 kA	100 kA	200 kA
600 Vac	14 kA	18 kA	25 kA	50 kA	100 kA

**PowerPact M-Frame Molded Case Circuit Breakers**

Table 7.67: M-Frame 800 A, Basic Electronic Trip System Type ET 1.0 [33] Factory-Sealed Trip Unit

Electronic Trip Unit		Sensor Rating	Interrupting Rating		Terminal Wire Range (AWG/kcmil)
Type	Function		G	J	
<b>2P, 600 Vac 50/60 Hz</b>					
Basic	Fixed Long-time, Adjustable Instantaneous Trip	300 A	MGL26300	MJL26300	AL800M23K (3) 3/0–500 Al/Cu
		350 A	MGL26350	MJL26350	
		400 A	MGL26400	MJL26400	
		450 A	MGL26450	MJL26450	
		500 A	MGL26500	MJL26500	
		600 A	MGL26600	MJL26600	
		700 A	MGL26700	MJL26700	
		800 A	MGL26800	MJL26800	
<b>3P, 600 Vac 50/60 Hz</b>					
Basic	Fixed Long-time, Adjustable Instantaneous Trip	300 A	MGL36300	MJL36300	AL800M23K (3) 3/0–500 Al/Cu
		350 A	MGL36350	MJL36350	
		400 A	MGL36400	MJL36400	
		450 A	MGL36450	MJL36450	
		500 A	MGL36500	MJL36500	
		600 A	MGL36600	MJL36600	
		700 A	MGL36700	MJL36700	
		800 A	MGL36800	MJL36800	

Table 7.68: Termination Options

Termination Letter	Termination Option
A	I-Line (See Section 9)
F	No lugs
L	Lugs both ends
M	Lugs ON end, terminal nut kit OFF end
P	Lugs OFF end, terminal nut kit ON end

M G L 3 6 4 0 0

For factory-installed termination, place termination letter in the third block of the circuit breaker catalog number.

Table 7.69: Frame Interrupting Ratings

Voltage	Interrupting Rating			
	D	G	J	L
240 Vac	25 kA	65 kA	100 kA	125 kA
480 Vac	18 kA	35 kA	65 kA	100 kA
600 Vac	14 kA	18 kA	25 kA	50 kA

Accessories see page 7-54  
Optional Lugs see page 7-59  
Dimensions see page 7-75  
Enclosures see page 7-76

[33] The ET 1.0 trip unit cannot be field replaced or have the long-time trip point setting adjusted. It is considered an electronic equivalent of a thermal-magnetic circuit breaker.

**Table 7.70: P-Frame Interrupting Ratings**

Voltage	P-Frame Interrupting Rating			
	G	J	K	L
240 Vac	65 kA	100 kA	65 kA	125 kA
480 Vac	35 kA	65 kA	50 kA	100 kA
600 Vac	18 kA	25 kA	50 kA	25 kA

**Table 7.71: P-Frame Termination Options**

Termination Letter
F = No Lugs (Includes terminal nut kit on both ends)
L = Lugs both ends
M = Lugs ON end, terminal nut kit OFF end
P = Lugs OFF end, terminal nut kit ON end
D = Drawout
A = I-Line (See Section 9)
P G L 3 6 0 4 0 U 4 1 A
For factory-installed termination, place termination letter in the third block of the circuit breaker catalog number.

Dimensions see page 7-75

Trip Unit Options see page 7-66

Optional Lugs see page 7-59

Alternate Rating Plugs see page 7-68

Enclosures see page 7-76

Accessories see page 7-54

**PowerPact P-Frame Molded Case Circuit Breakers**  
**Table 7.72: P-Frame 1200 A (600 Vac, 50/60 Hz) 3P [34] Circuit Breaker with Electronic Trip Unit**

Type	Electronic Trip Unit		Sensor Rating	Cat. No. [35]	Terminal Wire Range
	Function	Trip Unit			
Basic Electronic Trip Unit (Not Interchangeable)	Fixed long-time, Adjustable Instantaneous	E-T1.01	600 A	P■L36060	AL800M23K
			800 A	P■L36080	(3) 3/0 AWG-500 kcmil Al or Cu
			1000 A	P■L36100	AL1200P25K
			1200 A	P■L36120	(4) 3/0 AWG-500 kcmil Al or Cu
Micrologic Interchangeable Standard Trip Unit	LI	3.0	250 A	P■L36025(C)U31A	AL800M23K
			400 A	P■L36040(C)U31A	(3) 3/0 AWG-500 kcmil Al or Cu
			600 A	P■L36060(C)U31A	
			800 A	P■L36080(C)U31A	
	LSI	5.0	1000 A	P■L36100(C)U31A	AL1200P25K
			1200 A	P■L36120(C)U31A	(4) 3/0 AWG-500 kcmil Al or Cu
			250 A	P■L36025(C)U33A	AL800M23K
			400 A	P■L36040(C)U33A	(3) 3/0 AWG-500 kcmil Al or Cu
			600 A	P■L36060(C)U33A	
			800 A	P■L36080(C)U33A	
			1000 A	P■L36100(C)U33A	AL1200P25K
			1200 A	P■L36120(C)U33A	(4) 3/0 AWG-500 kcmil Al or Cu
Micrologic Interchangeable Ammeter Trip Unit	LI	3.0A	250 A	P■L36025(C)U41A	AL800M23K
			400 A	P■L36040(C)U41A	(3) 3/0 AWG-500 kcmil Al or Cu
			600 A	P■L36060(C)U41A	
			800 A	P■L36080(C)U41A	
	LSI	5.0A	1000 A	P■L36100(C)U41A	AL1200P25K
			1200 A	P■L36120(C)U41A	(4) 3/0 AWG-500 kcmil Al or Cu
			250 A	P■L36025(C)U43A	AL800M23K
			400 A	P■L36040(C)U43A	(3) 3/0 AWG-500 kcmil Al or Cu
	LSIG	6.0A	600 A	P■L36060(C)U43A	
			800 A	P■L36080(C)U43A	
			1000 A	P■L36100(C)U43A	AL1200P25K
			1200 A	P■L36120(C)U43A	(4) 3/0 AWG-500 kcmil Al or Cu
Micrologic Interchangeable Power Trip Unit	LSI	5.0P	250 A	P■L36025(C)U63AE1	AL800M23K
			400 A	P■L36040(C)U63AE1	(3) 3/0 AWG-500 kcmil Al or Cu
			600 A	P■L36060(C)U63AE1	
			800 A	P■L36080(C)U63AE1	
	LSIG	6.0P	1000 A	P■L36100(C)U63AE1	AL1200P25K
			1200 A	P■L36120(C)U63AE1	(4) 3/0 AWG-500 kcmil Al or Cu
			250 A	P■L36025(C)U64AE1	AL800M23K
			400 A	P■L36040(C)U64AE1	(3) 3/0 AWG-500 kcmil Al or Cu
	LSIG	6.0P	600 A	P■L36060(C)U64AE1	
			800 A	P■L36080(C)U64AE1	
			1000 A	P■L36100(C)U64AE1	AL1200P25K
			1200 A	P■L36120(C)U64AE1	(4) 3/0 AWG-500 kcmil Al or Cu
Micrologic Interchangeable Harmonic Trip Unit	LSI	5.0H	250 A	P■L36025(C)U73AE1	AL800M23K
			400 A	P■L36040(C)U73AE1	(3) 3/0 AWG-500 kcmil Al or Cu
			600 A	P■L36060(C)U73AE1	
			800 A	P■L36080(C)U73AE1	
	LSIG	6.0H	1000 A	P■L36100(C)U73AE1	AL1200P25K
			1200 A	P■L36120(C)U73AE1	(4) 3/0 AWG-500 kcmil Al or Cu
			250 A	P■L36025(C)U74AE1	AL800M23K
			400 A	P■L36040(C)U74AE1	(3) 3/0 AWG-500 kcmil Al or Cu
	LSIG	6.0H	600 A	P■L36060(C)U74AE1	
			800 A	P■L36080(C)U74AE1	
			1000 A	P■L36100(C)U74AE1	AL1200P25K
			1200 A	P■L36120(C)U74AE1	(4) 3/0 AWG-500 kcmil Al or Cu

[34] For 2P and 4P information see Catalog 0612CT0101.

[35] To complete the catalog number:

Replace the ■ with the appropriate interrupting rating (G, J, K or L).

For all L interrupting ratings, change the 5th character (voltage rating) from a 6 (600 V) to a 4 (480V). The 480 V AIR is standard 100 kA.

For 100% rated circuit breakers, add a "C" in the 9th character place. For example, the catalog number for a 100% rated trip unit with LI trip functions at 250 A would be PBL36025CU31A.

**PowerPact R-Frame Molded Case Circuit Breakers**

R-frame circuit breakers can be bus- or cable-connected. For cable connections, optional terminal pad kit RLTB or equivalent bus structure is required. Each RLTB kit contains terminal pads for one end of the circuit breaker only and has provisions for mounting a maximum of 8 lugs per phase (9 lugs for 3000 A). RLTB kits are included with 2500 A 100% rated circuit breakers. The RL3TB kits are included with the 3000 A, 80% and 100% rated circuit breakers. For other circuit breakers, order terminal pad kit (RLTB) and optional lugs separately. See page 7-59–page 7-61.

**Table 7.73: R-Frame Interrupting Ratings**

Voltage	R-Frame Interrupting Rating			
	G	J	K	L
240 Vac	65 kA	100 kA	65 kA	125 kA
480 Vac	35 kA	65 kA	65 kA	100 kA
600 Vac	18 kA	25 kA	65 kA	50 kA

**Table 7.74: R-Frame 3000 A (600 Vac, 50/60 Hz) 3P Circuit Breaker with Electronic Trip Unit**

Type	Electronic Trip Unit <sup>[36]</sup>		Sensor Rating	Cat. No. <sup>[37]</sup>
	Function	Trip Unit		
Basic Electronic Trip Unit (Not Interchangeable)	Fixed long-time, Adjustable Instantaneous	ET1.0I	1200 A	R■F36120
			1600 A	R■F36160
			2000 A	R■F36200
			2500 A	R■F36250
			3000 A	R■F36300
Micrologic Interchangeable Standard Trip Unit	LI	3.0	600 A	R■F36060(C)U31A
			800 A	R■F36080(C)U31A
			1000 A	R■F36100(C)U31A
			1200 A	R■F36120(C)U31A
			1600 A	R■F36160(C)U31A
			2000 A	R■F36200(C)U31A
			2500 A	R■F36250(C)U31A
	LSI	5.0	600 A	R■F36060(C)U33A
			800 A	R■F36080(C)U33A
			1000 A	R■F36100(C)U33A
			1200 A	R■F36120(C)U33A
			1600 A	R■F36160(C)U33A
			2000 A	R■F36200(C)U33A
			2500 A	R■F36250(C)U33A
			3000 A	R■F36300(C)U33A
Micrologic Interchangeable Ammeter Trip Unit	LI	3.0A	600 A	R■F36060(C)U41A
			800 A	R■F36080(C)U41A
			1000 A	R■F36100(C)U41A
			1200 A	R■F36120(C)U41A
			1600 A	R■F36160(C)U41A
			2000 A	R■F36200(C)U41A
			2500 A	R■F36250(C)U41A
	LSI	5.0A	600 A	R■F36060(C)U43A
			800 A	R■F36080(C)U43A
			1000 A	R■F36100(C)U43A
			1200 A	R■F36120(C)U43A
			1600 A	R■F36160(C)U43A
			2000 A	R■F36200(C)U43A
			2500 A	R■F36250(C)U43A
			3000 A	R■F36300(C)U43A
LSIG	6.0A	600 A	■F36060(C)U44A	
		800 A	R■F36080(C)U44A	
		1000 A	R■F36100(C)U44A	
		1200 A	R■F36120(C)U44A	
		1600 A	R■F36160(C)U44A	
		2000 A	R■F36200(C)U44A	
		2500 A	R■F36250(C)U44A	
		3000 A	R■F36300(C)U44A	
		Micrologic Interchangeable Power Trip Unit	LSI	5.0P
800 A	R■F36080(C)U63AE1			
1000 A	R■F36100(C)U63AE1			
1200 A	R■F36120(C)U63AE1			
1600 A	R■F36160(C)U63AE1			
2000 A	R■F36200(C)U63AE1			
2500 A	R■F36250(C)U63AE1			
LSIG	6.0P		600 A	R■F36060(C)U64AE1
			800 A	R■F36080(C)U64AE1
			1000 A	R■F36100(C)U64AE1
			1200 A	R■F36120(C)U64AE1
			1600 A	R■F36160(C)U64AE1
			2000 A	R■F36200(C)U64AE1
			2500 A	R■F36250(C)U64AE1
			3000 A	R■F36300(C)U64AE1
Micrologic	LSI	5.0H	600 A	R■F36060(C)U73AE1

[36] For 2P and 4P information see Catalog 0612CT0101.

[37] To complete the catalog number: Replace the ■ with the appropriate interrupting rating (G, J, K or L); For 100% rated circuit breakers, add a "C" in the 9th character place. For example, the catalog number for a 100% rated trip unit with LI trip functions at 2500 A would be GF36025CU31A.

**Table 7.74 R-Frame 3000 A (600 Vac, 50/60 Hz) 3P Circuit Breaker with Electronic Trip Unit (cont'd.)**

Type	Electronic Trip Unit <sup>[36]</sup>		Sensor Rating	Cat. No. <sup>[37]</sup>
	Function	Trip Unit		
Interchangeable Harmonic Trip Unit			800 A	R■F36080(C)U73AE1
			1000 A	R■F36100(C)U73AE1
			1200 A	R■F36120(C)U73AE1
			1600 A	R■F36160(C)U73AE1
			2000 A	R■F36200(C)U73AE1
			2500 A	R■F36250(C)U73AE1
	LSIG	6.0H	3000 A	R■F36300(C)U73AE1
			600 A	R■F36060(C)U74AE1
			800 A	R■F36080(C)U74AE1
			1000 A	R■F36100(C)U74AE1
			1200 A	R■F36120(C)U74AE1
			1600 A	R■F36160(C)U74AE1
			2000 A	R■F36200(C)U74AE1
			2500 A	R■F36250(C)U74AE1
		3000 A	R■F36300(C)U74AE1	

[36] For 2P and 4P information see Catalog 0612CT0101.

[37] To complete the catalog number: Replace the ■ with the appropriate interrupting rating (G, J, K or L); For 100% rated circuit breakers, add a "C" in the 9th character place. For example, the catalog number for a 100% rated trip unit with LI trip functions at 2500 A would be GF36025CU31A.

**Motor Circuit Protection Selection**

PowerPact H- and J-frame electronic Motor Circuit Protectors (MCP) are magnetic-only instantaneous-trip circuit breakers. They are designed to offer short circuit protection and are National Electrical Code (NEC) compliant when installed as part of a combination controller having motor overload protection. MCP circuit breakers accept the same accessories and terminals as the equivalent thermal-magnetic circuit breakers.

Determine the hp rating from the nameplate of the motor. Select a MCP with an ampere rating recommended for the hp and voltage involved. When using the automatic settings the MCP microprocessor automatically adjusts the trip settings for both current and time to align with the start-up characteristic for the motor type, whether it is a standard or energy-efficient motor. This includes a dampening means to accommodate a transient motor in-rush current without nuisance tripping of the circuit breaker.

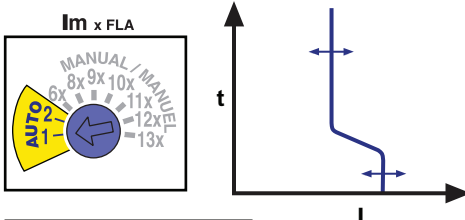
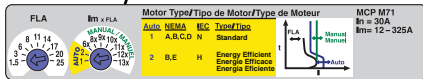
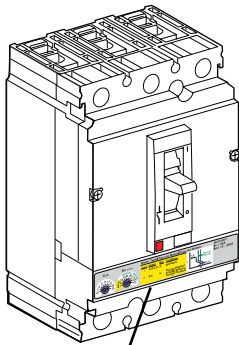

Motor Type / Tipo de Motor / Type de Moteur	Auto	NEMA	IEC	Type/Typo
1	A, B, C, D	N	Standard	Standard
2	B, E	H	Energy Efficient Energie Efficace Energia Efficente	

**Table 7.75: H- and J-Frame Electronic Motor Circuit Protectors (MCP)**

Frame	Sensor Rating	Full Load Amperes Range	Adjustable Instantaneous Trip Range	Suffix	Interrupting Rating		
					J (See SCCR Table Below) Cat. No.	L (See SCCR Table Below) Cat. No.	R (See SCCR Table Below) Cat. No.
H-Frame	30 A	1.5–25 A	9–325 A	M71	HJL36030M71	HLL36030M71	HRL36030M71
	50 A	14–42 A	84–546 A	M72	HJL36050M72	HLL36050M72	HRL36050M72
	100 A	30–80 A	180–1040 A	M73	HJL36100M73	HLL36100M73	HRL36100M73
	150 A	58–130 A	348–1690 A	M74	HJL36150M74	HLL36150M74	HRL36150M74
J-Frame	250 A	114–217 A	684–2500 A	M75	JJL36250M75	JLL36250M75	JRL36250M75

**Table 7.76: Maximum Rating or Setting of Motor Protective Devices [1]**

Type of Motor	Percentage of Full-load Current		
	Setting	Not to Exceed[2]	
A, B, C, D	Standard	800%	1300%
B, E	Energy Efficient	1100%	1700%

**Table 7.77: MCP Selection by HP Ratings [3] of Induction-type Squirrel-Cage and Wound-Rotor Motors [4]**

200 Vac	3Ø 60 Hz Voltages[5]			Full-Load Amperes	Suffix
	230 Vac	460 Vac	575 Vac		
5–5	5–7.5	7.5–15	1–20	1.5–25	M71
5–10	5–15	10–30	15–40	14–42	M72
10–25	15–30	25–60	30–75	30–80	M73
20–40	25–50	50–100	60–125	58–130	M74
40–60	50–75	100–150	125–200	114–217	M75

**Short Circuit Current Rating (SCCR)**

Tested to meet NEC and UL508A requirements for short circuit current ratings as part of an approved combination controller.

**Table 7.78: Short Circuit Current Ratings (SCCR)**

Contactor/Starter	Interrupting Rating					
	J			L		
	200–240 Vac	480 Vac	600 Vac	200–240 Vac	480 Vac	600 Vac
Tesys D-line and F-line	100 kA	65 kA	25 kA	125 kA	100 kA	50 kA
NEMA Type S	100 kA	65 kA	25 kA	125 kA	100 kA	50 kA

See www.us.schneider-electric.us for specific ratings and combination ID numbers.

To select combination starters and motor controllers using MCP's Meeting NEC Article 430, refer to Section 16.

Accessories see page 7-54  
Lugs see page 7-59  
Dimensions see page 7-75  
Enclosures see page 7-76

[1] Based on 2005 NEC Table 430.52.  
[2] See NEC Exception No. 1 to Table 430.52. The NEC 1300% maximum setting may be inadequate for instantaneous trip circuit breakers to withstand current surges typical of the magnetization current of autotransformer type reduced voltage starters, or open transition wye-delta starters during transfer from "start" to "run," constant hp multi-speed motors, and motors labeled "high efficiency."  
[3] Based on 2005 NEC Table 430.250.  
[4] Per NEC 430.3, part-winding motors should select two circuit breakers, each at not more than one-half the allowable trip setting for the horsepower rating. The two circuit breakers should operate simultaneously as a disconnecting means per NEC 430.103.  
[5] Listed voltages are rated motor voltages. Corresponding system voltages are 200 Vac, 220–240 Vac, 440–480 Vac and 550–600 Vac. Select wire and circuit breakers based on horsepower rather than nameplate full-load current per NEC 430.6 (A) for general motor applications.

**H-, J-Frame Motor Circuit Protectors**

**Table 7.79: Application of PowerPact™ H-Frame and J-Frame Electronic Motor Circuit Protectors (MCP)**

Starter Size	Horsepower Rating of Induction-Type Squirrel-Cage and Wound-Rotor Motors 3Ø 60 Hz				NEC Full Load Amperes	PowerPact H-Frame and J-Frame Electronic MCP
	200 Vac	230 Vac	480 Vac	575 Vac		
00			1/2	1/2	0.9 A	HJL36030M71 and HLL36030M71 1/2–10 hp
				3/4	1.1 A	
			3/4	1	1.3 A	
			1		1.7 A	
					2.1 A	
			1/2		2.2 A	
				1-1/2	2.4 A	
		1/2			2.5 A	
				2	2.7 A	
			1-1/2		3 A	
			3/4		3.2 A	
			2		3.4 A	
		3/4			3.7 A	
				3	3.9 A	
			1		4.2 A	
0			3		4.8 A	
					4.8 A	
			1-1/2		6 A	
			2		6.1 A	
				5	6.8 A	
		1-1/2			6.9 A	
			5		7.6 A	
		2			7.8 A	
				7-1/2	9 A	
			3		9.6 A	
1			7-1/2	10	11 A	
			10		14 A	
			5		15.2 A	
				15	17 A	
			15		17.5 A	
2				20	21 A	
					22 A	
			7-1/2		25.3 A	
			20		27 A	
				25	28 A	
				30	32 A	
					32.2 A	
		10			34 A	
			25		40 A	
			30		41 A	
3				40	42 A	
					48.3 A	
		15			52 A	
			40	50	54 A	
				60	62 A	
			20		65 A	
			25		68 A	
			60	75	77 A	
					78.2 A	
		25			80 A	
4		30			92 A	
			75		96 A	
				100	99 A	
					104 A	
		40			120 A	
5			100		124 A	
				125	125 A	
			50		130 A	
				150	144 A	
		50			150 A	
			60		154 A	
			125		156 A	
			150		177.1 A	
					180 A	
			75	200	192 A	
				221 A		
			200	240 A		
		100		248 A		

Shaded area is not covered by J-frame electronic motor circuit protector.



### Instantaneous Trip Circuit Breakers

Adjustable instantaneous-trip circuit breakers are intended for use in combination with motor starters with overload relays for the protection of motor circuits from short circuits. Other specific applications include rectifiers and resistance welders. These circuit breakers contain a magnetic trip element in each pole with the trip point adjustable from the front. Interrupting ratings are determined by testing the instantaneous-trip circuit breakers in combination with a contactor and overload relay.

Select instantaneous-trip circuit breakers as follows:

This selection table is suitable for motors, other than NEMA Design E, with locked-rotor indicating code letters per NEC® Table 430.7 (b) as follows:

**Table 7.80: Locked-Rotor Indicating Codes**

Horsepower	Motor Code Letter
1/2 or less	A-L
3/4 to 1-1/2	A-K
2 to 3	A-J
5 to 25	A-H
30 to 125	A-G
150 or more	A-F

- For other motors order a special thermal-magnetic circuit breaker with magnetic trip settings for the specific motor— specify motor horsepower, voltage, frequency, full-load current and code letter or locked rotor current.
- Determine motor hp rating from the motor nameplate.
- Refer to the tables and select an instantaneous-trip circuit breaker with an ampere rating recommended for the hp and voltage involved.
- Select an adjustable trip setting of at least 800%, not to exceed 1300%, of the motor full-load amperes (FLA) for other than Design E motors. For Design E motors, select an adjustable trip setting of at least 1100% not to exceed 1700% of FLA.
- The NEC 1300% maximum setting may be inadequate for instantaneous-trip circuit breakers to withstand current surges typical of the magnetization current of autotransformer type reduced voltage starters, or open transition wye-delta starters during transfer from “start” to “run,” constant hp multi-speed motors, and motors labeled “high efficiency.” Select thermal-magnetic circuit breakers from [page 7-47](#) for those applications.
- Part-winding motors, per NEC 430.3, should have two circuit breakers selected from the above at not more than one half the allowable trip setting for the horsepower rating. The two circuit breakers should operate simultaneously as a disconnecting means per NEC 430.103.
- Based on NEC 430.52 and NEC Table 430.150. See [page 7-45](#) for available Adjustable Instantaneous-Trip Circuit Breakers.



Motor Circuit Protector



Motor Protector Circuit Breaker

**Motor Circuit Protectors**

Mag-Gard™ Motor Circuit Protectors (MCP) are instantaneous-trip magnetic-only circuit breakers. They have a single adjustment which simultaneously sets the magnetic trip level of each individual pole. Mag-Gard™ circuit breakers comply with NEC requirements for providing motor circuit protection when installed as part of a UL Listed combination controller having motor overload protection. Interrupting ratings are established for these UL Recognized Components only when they are used in combination with motor starters with properly sized overload relays and contactors.

All Mag-Gard circuit breakers will accept the same lugs and accessories as equivalent circuit breakers. Mag-Gard circuit breakers are available with I-Line construction [6]. High-interruption (H) construction Mag-Gard circuit breakers (LHL) are also available.

**Table 7.81: Magnetic Only 3 Pole, 600 Vac, 50/60 Hz [6]—Three Device Solutions [7]**

Ampere Rating	Trip Unit	Adjustable [8] Trip Range (A)	250 Vdc Multiplier	Cat. No.
LAL	400	—	High = 1.2 Low = 1.4	LAL3640022M
				LAL3640028M
				LAL3640030M
				LAL3640031M
				LAL3640032M
				LAL3640033M
				LAL3640035M
				LAL3640036M

For PowerPact L- and P-Frames, an instantaneous-only version of the electronic trip circuit breaker is also available for motor circuit protection. These MCPs comply with NEC® requirements for providing short-circuit protection when installed as part of a Listed combination controller having motor overload protection.

**Table 7.82: Magnetic Only 3 Pole, 600 Vac, 50/60 Hz [6]—Three Device Solutions [7]**

Sensor Rating	Trip Unit	Adjustable [8] Trip Range (A)	Interrupting Rating			
			G	J	L	R
PowerPact L-Frame [6]	400	500–1200%	LGL36400M37X	LJL36400M37X	LLL36400M37X	LRL36400M37X
	600	500–1200%	LGL36600M37X	LJL36600M37X	LLL36600M37X	LRL36600M37X
PowerPact P.JL, PLL [6]	600	1200–10000 A	—	PJL36060M68	PLL34060M68	—
	800	1200–10000 A	—	PJL36080M68	PLL34080M68	—
	1000	1500–10000 A	—	PJL36100M69	PLL34100M69	—
	1200	1800–10000 A	—	PJL36120M70	PLL34120M70	—

**Motor Protector Circuit Breakers**

Motor protection circuit breakers provide built-in thermal and magnetic protection. They are used in two-device motor feeder solutions to provide protection against short-circuits, overloads, and phase unbalance.

**Table 7.83: H-Frame (150 A), J-Frame (250 A) and L-Frame (600 A) Electronic Motor Protector Circuit Breakers (UL Ratings)—Two Device Solutions [9]**

Electronic Trip Unit Type	Frame	Sensor Rating	Trip Unit	Full Load Amperes Range (FLA)	Isd (x FLA)	Interrupting Rating			
						G	J	L	R
Standard [10]	H-Frame	30	2.2 M	14–25	5-13 x FLA	HGL36030M38X	HJL36030M38X	HLL36030M38X	HRL36030M38X
		50		14–42	5-13 x FLA	HGL36050M38X	HJL36050M38X	HLL36050M38X	HRL36050M38X
		100		30–80	5-13 x FLA	HGL36100M38X	HJL36100M38X	HLL36100M38X	HRL36100M38X
		150		58–130	5-13 x FLA	HGL36150M38X	HJL36150M38X	HLL36150M38X	HRL36150M38X
	J-Frame	250	2.3 M	114–217	5-13 x FLA	JGL36250M38X	JJL36250M38X	JLL36250M38X	JRL36250M38X
	L-Frame	400		190–348	5-13 x FLA	LGL36400M38X	LJL36400M38X	LLL36400M38X	LRL36400M38X
		600	312–520	5-13 x FLA	LGL36600M38X	LJL36600M38X	LLL36600M38X	LRL36600M38X	

Accessories see page 7-54 and Supplemental Digest Section 3

Optional Lugs see page 7-59 and Supplemental Digest Section 3

Dimensions see page 7-75

Enclosures see page 7-76

**To select combination starters and motor controllers using MCP's meeting NEC Article 430, refer to Section 16.**

[6] These electronic magnetic-only motor circuit protectors are available with I-Line constructions. Consult the factory.

[7] Three-device solutions are the traditional solutions: motor circuit protector plus motor starter plus overload relay.

[8] UL magnetic trip tolerances are -20%/+30% from the nominal values shown.

[9] Two-device solutions (these electronic motor protector circuit breakers include short circuit and overload protection)  
—1 electronic motor circuit protector with a Micrologic 2.2 M plus  
—1 contactor

[10] The standard trip unit offers Class 5, 10 and 20 and phase unbalance or phase loss protection.

**Table 7.84: PowerPact H- and L-Frame Motor Protector Circuit Breaker**

Hp Ratings of Induction Type Squirrel-Cage and Wound Rotor Motors 3Ø 60 Hz				Full Load Amperes <sup>[11]</sup>	PowerPact Family Motor Protector Circuit Breaker Cat. No. <sup>[12]</sup>	Magnetic Trip Settings <sup>[13]</sup>	
200 Vac	230 Vac	460 Vac	575 Vac			MIN	MAX
5	5	10	15	14	H(L)36030M38X	500%	1300%
				15.2	H(L)36030M38X		
				17	H(L)36030M38X		
				17.5	H(L)36030M38X		
7-1/2	7-1/2	15	20	21	H(L)36030M38X	500%	1300%
				22	H(L)36030M38X		
				25.3	H(L)36030M38X		
				27	H(L)36050M38X		
10	10	20	25	28	H(L)36050M38X	500%	1300%
				32	H(L)36050M38X		
				32.2	H(L)36050M38X		
				34	H(L)36050M38X		
15	15	30	40	40	H(L)36050M38X	500%	1300%
				41	H(L)36050M38X		
				42	H(L)36050M38X		
				48.3	H(L)36100M38X		
20	20	40	50	52	H(L)36100M38X	500%	1300%
				54	H(L)36100M38X		
				62	H(L)36100M38X		
				65	H(L)36100M38X		
75	100	200	250	221	L(L)36400M38X	500%	1300%
				240	L(L)36400M38X		
				242	L(L)36400M38X		
				248	L(L)36400M38X		
100	125	250	300	285	L(L)36400M38X	500%	1300%
				289	L(L)36400M38X		
				302	L(L)36400M38X		
				312	L(L)36400M38X		
125	150	300	350	336	L(L)36600M38X	500%	1300%
				359	L(L)36600M38X		
				360	L(L)36600M38X		
				361	L(L)36600M38X		
150	200	350	500	382	L(L)36600M38X	500%	1300%
				414	L(L)36600M38X		
				472	L(L)36600M38X		
				477	L(L)36600M38X		
		400		480	L(L)36600M38X		

**Table 7.85: LAL Adjustable Instantaneous-Trip Circuit Breakers for Single Motor Circuit Protection**

Hp Ratings of Induction Type Squirrel-Cage and Wound Rotor Motors 3Ø 60 Hz				Full Load Amperes <sup>[11]</sup>	Mag-Gard Circuit Breaker Cat. No.	Magnetic Trip Settings <sup>[13]</sup>	
200 Vac	230 Vac	460 Vac	575 Vac			MIN	MAX
75	100	200	250	221	LAL3640033M	700%	1400%
				240	LAL3640035M	700%	1500%
				242	LAL3640035M	700%	1400%
				248	LAL3640035M	700%	1400%
100	125	250	300	285	LAL3640036M	700%	1400%
				289	LAL3640036M	700%	1400%
				302	LAL3640036M	700%	1300%
				312	LAL3640036M	600%	1300%

[11] Motor full-load currents are taken from NEC Table 430.150. Select wire and circuit breakers on basis of horsepower rather than nameplate full-load current per NEC 430.6 (A) for general motor applications. Do not use these values to select overload relay thermal units. See Digest Section 14 for selection of thermal units when actual full load current is not known. The voltages listed are rated motor voltages. Corresponding nominal system voltages are 200–208, 220–240, 440–480 and 550–600 V.

[12] To complete catalog number, replace the blank with the appropriate rating (G, J, L or R).

[13] Only MIN and MAX settings are shown, intermediate settings are available on all circuit breakers.

**Motor Circuit Protection Selection**

**Table 7.86: Selection Tables for Conductors, Safety Switches and Thermal-Magnetic Circuit Breakers Based on 2005 NEC® Tables 430.147, 430.148 & 430.150**

Horsepower Ratings									Full Load Amperage [14]	Amperage of Thermal-Magnetic [15][16] Inverse Time Circuit Breaker		QMB and Heavy Duty Switch with Time Delay Fuses [17]	Minimum Size metallic Conduit 75° C, C Wire Field-Installed Sized for 125% FLA [18]			
Squirrel-Cage and Wound-Rotor Motors with Norm. Torque Characteristics Operating at Usual Speeds				1Ø 10 Hz ac		Average Direct Current Motors Operating at Base Speed				For Motor Code Letter B to E			AWG kcmil	Conduit 3 W		
3Ø 60 Hz				115 Vac	200 Vac [22]	230 Vac	120 Vdc	240 Vdc		Ordinary Service [20]	Heavy Service and Energy Efficient [21]			For Motor Code Letter F to V [19]	THHN THWN XHHW	THW
200 Vac [22]	230 Vac	460 Vac	575 Vac													
				1/3		3/4			6.9 A							
									7.2 A							
									7.6 A							
2			5					3.4	7.8 A							
									7.9 A							
									8.0 A							
									8.5 A							
									9.0 A							
									9.2 A							
									9.5 A							
									9.6 A							
									9.8 A							
									10.0 A							
									11.0 A							
									11.5 A							
									12.0 A							
									12.2 A							
									13.2 A							
									13.8 A							
									14.0 A							
									15.2 A							
									16.0 A							
									17.0 A							
									17.5 A							
									19.6 A							
									20.0 A							
									21.0 A							
									22.0 A							
									24.0 A							
									25.0 A							
									25.3 A							
									27.0 A							
									28.0 A							
									29.0 A							
									32.0 A							
									32.2 A							
									34.0 A							
									38.0 A							
									40.0 A							
									41.0 A							
									42.0 A							
									46.0 A							
									48.3 A							
									50.0 A							
									52.0 A							
									54.0 A							
									55.0 A							
									56.0 A							
									57.5 A							
									58.0 A							
									62.0 A							
									62.1 A							
									65.0 A							
									68.0 A							
									72.0 A							
									76.0 A							
									77.0 A							

[14] Motor full load currents thru 200 hp are taken from NEC Tables 430.147, 148 and 150. Above 200 hp from UL 98. Select wire size, circuit breakers, or fuses on basis of hp rather than nameplate full load current per NEC 430.6. Do not use these values to select overload relay thermal units. See Digest pages 16-129—16152 for selection of thermal units when actual full load current is not known. Voltages listed are rated motor voltages. Corresponding nominal system voltages are 110–120 V, 200–208 V, 220–240 V, 440–480 V and 550–600 V

[15] Thermal-magnetic circuit breaker ampere ratings recommended are approximate for average conditions, based on trip characteristics of Square D circuit breakers and NEC Table 430.52. Under some conditions, the next size larger switch or circuit breaker rating may be necessary to accommodate the motor starting current and is permitted by NEC 430.52(C)(1) Exception 2. High starting currents are anticipated with Design E and other energy efficient motors. For explanation of Code letter markings, see NEC 430.7(B). For Busway Plug-in units, see page 9-7.

[16] Type LC, LI, LX, LXI, and LE circuit breakers are NOT recommended for use on single motor branch circuits.

[17] Switch size only is shown in table. Selected fuses should not exceed maximum percent of full-load current as given in NEC Table 430.52. Above 50 hp dc switches are not hp rated by UL as Motor Circuit Switches, but as General Use Switches only and are not necessarily capable of interrupting the max. operating overload current of a motor. See NEC 100 for definition of General Use Switch. When protecting a 3Ø, Design E energy efficient motor, the switch is required by NEC 430.109 to have a hp rating of not less than 1.4 times that of a motor rated 3–100 hp, or not less than 1.3 times that of a motor rated over 100 hp. Switches shown in this table do not necessarily comply with that requirement.

[18] NEC 430.22 for Single Motor, Smaller conductors may be permitted for light duty-cycle service per 430.22 (B) Exception No. 1. DC motors operating from rectified 1Ø power supply will require larger conductors per 430.22 (A) Exception No. 1. For motor-generator arc welders, see 630.11

[19] Thermal-magnetic breaker ampere ratings recommended are approximate for average conditions and based on trip characteristics of Square D circuit breakers and NEC Tables 430.7(B) and 430.52.

[20] Ordinary service for normal starting duty only, acceleration time of 10 sec. or less.

[21] Heavy service is jogging or plugging duty or cycling load with over 25 starts per hour or over 5 starts per minute. Energy efficient motors are polyphase motors defined in NEMA Standard MG1 and exhibit high starting current.

[22] 200 V motors are commonly used on 208 V services.

[23] 8 XHHW requires 3/4 in. conduit for 3W.

**Table 7.86 Selection Tables for Conductors, Safety Switches and Thermal-Magnetic Circuit Breakers Based on 2005 NEC® Tables 430.147, 430.148 & 430.150 (cont'd.)**

Horsepower Ratings										Full Load Amperage [14]	Amperage of Thermal-Magnetic [15][16] Inverse Time Circuit Breaker			QMB and Heavy Duty Switch with Time Delay Fuses [17]	Minimum Size metallic Conduit 75° C, C Wire Field-Installed Sized for 125% FLA [18]		
Squirrel-Cage and Wound-Rotor Motors with Norm. Torque Characteristics Operating at Usual Speeds 3Ø 60 Hz				1Ø 10 Hz ac			Average Direct Current Motors Operating at Base Speed		For Motor Code Letter B to E		For Motor Code Letter F to V [19]	AWG kcmil	Conduit 3 W				
200 Vac [22]	230 Vac	460 Vac	575 Vac	115 Vac	200 Vac [22]	230 Vac	120 Vdc	240 Vdc	Ordinary Service [20]				Heavy Service and Energy Efficient [21]		THHN THWN XHHW	THW	
25									78.2 A								
	30				7-1/2				80.0 A								
								25	89.0 A								
30									92.0 A	125 A				2	1 in.	1-1/4 in.	
		75							96.0 A		200 A	250 A					
			100						99.0 A					1	1-1/4 in.	1-1/2 in.	
				10					100.0 A	150 A							
	40								104.0 A								
								30	106.0 A	175 A		300 A		1/0	1-1/4 in.	1-1/2 in.	
40									120.0 A		250 A						
		100							124.0 A								
			125						125.0 A		250 A			2/0	1-1/2 in.	1-1/2 in.	
	50								130.0 A	200 A		350 A					
								40	140.0 A		300 A						
			150						144.0 A								
50									150.0 A					3/0	1-1/2 in.	2 in.	
	60								154.0 A			400 A					
		125							156.0 A	225 A	350 A						
								50	173.0 A					4/0	2 in.	2 in.	
60									177.0 A								
		150							180.0 A	250 A	400 A	500 A		250	2 in.	2 in.	
	75								192.0 A					300	2 in.	2-1/2 in.	
75			200						240.0 A	300 A	450 A	600 A					
		200							242.0 A					350	2-1/2 in.	2-1/2 in.	
			250						248.0 A	350 A	500 A	700 A					
	100								285.0 A								
100									289.0 A	400 A	600 A	800 A		500	3 in.	3 in.	
		250							302.0 A					(2) 3/0	(2) 2-1/2 in.	(2) 2 in.	
			350						312.0 A	450 A	700 A						
									336.0 A	500 A		900 A					
125									359.0 A					(2) 4/0	(2) 2 in.	(2) 2 in.	
	150								360.0 A								
		300							361.0 A	600 A	800 A	1000 A					
			400						382.0 A					(2) 300	(2) 2 in.	(2) 2-1/2 in.	
150									414.0 A		900 A						
		350							472.0 A								
			500						477.0 A	800 A	1000 A	1200 A		(2) 350	(2) 2-1/2 in.	(2) 2-1/2 in.	
									480.0 A								
200									552.0 A								
		500							590.0 A	900 A	1200 A	1600 A	—	(3) 300	(3) 2 in.	(3) 2-1/2 in.	
	250								602.0 A								

Contact your local Field Office for circuit breaker selection on constant horsepower multi-speed motors.

- [14] Motor full load currents thru 200 hp are taken from NEC Tables 430.147, 148 and 150. Above 200 hp from UL 98. Select wire size, circuit breakers, or fuses on basis of hp rather than nameplate full load current per NEC 430.6. Do not use these values to select overload relay thermal units. See Digest pages 16-129—16152 for selection of thermal units when actual full load current is not known. Voltages listed are rated motor voltages. Corresponding nominal system voltages are 110–120 V, 200–208 V, 220–240 V, 440–480 V and 550–600 V
- [15] Thermal-magnetic circuit breaker ampere ratings recommended are approximate for average conditions, based on trip characteristics of Square D circuit breakers and NEC Table 430.52. Under some conditions, the next size larger switch or circuit breaker rating may be necessary to accommodate the motor starting current and is permitted by NEC 430.52(C)(1) Exception 2. High starting currents are anticipated with Design E and other energy efficient motors. For explanation of Code letter markings, see NEC 430.7(B). For Busway Plug-in units, see page 9-7.
- [16] Type LC, LI, LX, LXI, and LE circuit breakers are NOT recommended for use on single motor branch circuits.
- [17] Switch size only is shown in table. Selected fuses should not exceed maximum percent of full-load current as given in NEC Table 430.52. Above 50 hp dc switches are not hp rated by UL as Motor Circuit Switches, but as General Use Switches only and are not necessarily capable of interrupting the max. operating overload current of a motor. See NEC 100 for definition of General Use Switch. When protecting a 3Ø, Design E energy efficient motor, the switch is required by NEC 430.109 to have a hp rating of not less than 1.4 times that of a motor rated 3–100 hp, or not less than 1.3 times that of a motor rated over 100 hp. Switches shown in this table do not necessarily comply with that requirement.
- [18] NEC 430.22 for Single Motor, Smaller conductors may be permitted for light duty-cycle service per 430.22 (B) Exception No. 1. DC motors operating from rectified 1Ø power supply will require larger conductors per 430.22 (A) Exception No. 1. For motor-generator arc welders, see 630.11
- [19] Thermal-magnetic breaker ampere ratings recommended are approximate for average conditions and based on trip characteristics of Square D circuit breakers and NEC Tables 430.7(B) and 430.52.
- [20] Ordinary service for normal starting duty only, acceleration time of 10 sec. or less.
- [21] Heavy service is jogging or plugging duty or cycling load with over 25 starts per hour or over 5 starts per minute. Energy efficient motors are polyphase motors defined in NEMA Standard MG1 and exhibit high starting current.
- [22] 200 V motors are commonly used on 208 V services.



J-Frame Switch



L-Frame Switch

**PowerPact Automatic Switches**

Automatic molded case switches open instantaneously at a factory preset magnetic trip point, calibrated to protect only the molded case switch itself, when it is subjected to high fault currents. The trip point is nonadjustable and provides no overload or low level fault protection.

Molded case switches open when the handle is switched to the OFF position or in response to an auxiliary tripping device such as a shunt trip.

All molded case switches will accept the same lugs and accessories as equivalent thermal-magnetic circuit breakers, with the exception of Q-frame switches which do not have electrical accessories available.

Automatic molded case switches are UL Listed per UL 489 and are CSA Certified.

**Table 7.87: PowerPact™ B-Frame Automatic Molded Case Switches, 600 Vac**

Circuit Breaker	Poles	Ampere Rating	D Withstand		G Withstand		J Withstand		Terminal	Wire Range
			Cat. No.	Trip Point	Cat. No.	Trip Point	Cat. No.	Trip Point		
B-Frame	2 [1]	125 A	BDL26000S12	1625 A	BGL26000S12	1625 A	BJL26000S12	1625 A	LV426973	14–2/0 AWG Cu
	3	125 A	BDL36000S12	1625 A	BGL36000S12	1625 A	BJL36000S12	1625 A	LV426974	14–2/0 AWG Cu

**Table 7.88: H-, J-, and L-Frame PowerPact™ Automatic Molded Case Switches, 600 Vac**

Circuit Breaker	Poles	Ampere Rating	G Withstand		L Withstand		R Withstand		Terminal	Wire Range
			Cat. No.	Trip Point	Cat. No.	Trip Point	Cat. No.	Trip Point		
H-Frame J-Frame	2	150 A	HGL26000S15 [1]	2250 A	HLL26000S15	2250 A	—	—	AL150HD	14 AWG–3/0 AWG Al/Cu
		175 A	JGL26000S17	3125 A	JLL26000S17	3125 A	—	—	AL175JD	4–4/0 AWG Al/Cu
		250 A	JGL26000S25	3125 A	JLL26000S25	3125 A	—	—	AL250JD	3/0 AWG–350 kcmil Al/Cu
	3	150 A	HGL36000S15	2250 A	HLL36000S15	2250 A	—	—	AL150HD	14 AWG–3/0 AWG Al/Cu
		175 A	JGL36000S17	3125 A	JLL36000S17	3125 A	JRL36000S17	3125 A	AL175JD	4–4/0 AWG Al/Cu
		250 A	JGL36000S25	3125 A	JLL36000S25	3125 A	JRL36000S25	3125 A	AL250JD	3/0 AWG–350 kcmil Al/Cu
L-Frame	3	400 A	LGL36000S40X	4800 A	LLL36000S40X	4800 A	LRL36000S40X	4800 A	AL150HD	AL600LS52K3
		600 A	LGL36000S60X	6600A	LLL36000S60X	6600 A	LRL36000S60X	6600 A	AL250JD	(2) 2/0 AWG–500 kcmil Al/Cu
		400 A	LGL46000S40X	4800 A	LLL46000S40X	4800 A	LRL46000S40X	4800 A	AL150HD	AL600LS52K4
	4	600 A	LGL46000S60X	6600A	LLL46000S60X	6600 A	LRL46000S60X	6600 A	AL250JD	(2) 2/0 AWG–500 kcmil Al/Cu

**Table 7.89: P-Frame and R-Frame PowerPact™ Automatic Molded Case Switches [2], 600 Vac**

Frame	Poles	Ampere Rating	J Withstand		K Withstand		L Withstand		Terminal	Wire Range	
			Cat. No.	Trip Point	Cat. No.	Trip Point	Cat. No.	Trip Point			
P	2	600 A	PJL26000S60	10 kA	PKL26000S60	24 kA	PLL24000S60 [3]	10 kA	AL800M23K	(3) 3/0 AWG–500 kcmil Al or Cu	
		800 A	PJL26000S80	10 kA	PKL26000S80	24 kA	PLL24000S80 [3]	10 kA			
		1000 A	PJL26000S10	10 kA	PKL26000S10	24 kA	PLL24000S10 [3]	10 kA	AL1200P25K	(4) 3/0 AWG–500 kcmil Al or Cu	
		1200 A	PJL26000S12	10 kA	PKL26000S12	24 kA	PLL24000S12 [3]	10 kA			
	3	600 A	PJL36000S60	10 kA	PKL36000S60	24 kA	PLL34000S60 [3]	10 kA	AL800M23K	(3) 3/0 AWG–500 kcmil Al or Cu	
		800 A	PJL36000S80	10 kA	PKL36000S80	24 kA	PLL34000S80 [3]	10 kA			
R	2	1000 A	PJL36000S10	10 kA	PKL36000S10	24 kA	PLL34000S10 [3]	10 kA	AL1200P25K	(4) 3/0 AWG–500 kcmil Al or Cu	
		1200 A	PJL36000S12	10 kA	PKL36000S12	24 kA	PLL34000S12 [3]	10 kA			
		1200 A	—	—	RKF26000S12	57 kA	RLF26000S12	48 kA			R-frame circuit breakers can be bus-connected or cable-connected. For cable connections, RLTB kit or equivalent bus structure is required. Kit is included with 3000 A switches. For all others, see page 7-62.
		1600 A	—	—	RKF26000S16	57 kA	RLF26000S16	48 kA			
		2000 A	—	—	RKF26000S20	57 kA	RLF26000S20	48 kA			
		2500 A	—	—	RKF26000S25	57 kA	RLF26000S25	48 kA			
	1200 A	—	—	RKF36000S12	57 kA	RLF36000S12	48 kA				
	1600 A	—	—	RKF36000S16	57 kA	RLF36000S16	48 kA				
	3	2000 A	—	—	RKF36000S20	57 kA	RLF36000S20	48 kA	R-frame circuit breakers can be bus-connected or cable-connected. For cable connections, RLTB kit or equivalent bus structure is required. Kit is included with 3000 A switches. For all others, see page 7-62.		
		2500 A	—	—	RKF36000S25	57 kA	RLF36000S25	48 kA			
		3000 A	—	—	RKF36000S30	57 kA	RLF36000S30	48 kA			

Accessories see page 7-54 and Supplemental Digest Section 3  
Optional Lugs see page 7-59 and Supplemental Digest Section 3  
Dimensions see page 7-74 and page 7-75  
Enclosures see page 7-76

**Table 7.90: Q-Frame (240 Vac) PowerPact™ Automatic Molded Case Switches**

Circuit Breaker	Poles	Ampere Rating	J Withstand		Wire Range
			Cat. No.	Trip Point	
Q-Frame [4]	2	225 A	QBL22000S22	4500 A	4 AWG–300 kcmil
	3	225 A	QBL32000S22	4500 A	

**Table 7.91: B-, H-, J-, L- P-, and R-Frame Withstand Ratings [5]**

Voltage	Withstand					
	D	G	J	K	L	R
240 Vac	25 kA	65 kA	100 kA	65 kA	125 kA	200 kA
480 Vac	18 kA	35 kA	65 kA	50 kA [6]	100 kA	200 kA
600 Vac	14 kA	18 kA	25 kA	50 kA [6]	50 kA	100 kA

[1] True 2P device. Others are a 2P in a 3P module.  
[2] UL magnetic trip tolerances are -20% / +30% from the nominal values shown.  
[3] P-frame L-interrupting is available in 480 Vac only.  
[4] Withstand rating of 10 kA at 240 Vac.  
[5] The withstand rating is the fault current at rated voltage that the molded case switch will withstand without damage when protected by a circuit breaker with an equal continuous current rating.  
[6] B- and R-frame withstand is 65 kA.

New!

500 Vdc Circuit Breakers

The UL Listed thermal-magnetic molded case circuit breakers shown below are specifically designed for use on ungrounded dc systems having a maximum short-circuit voltage of 500 Vdc or a maximum floating (unloaded) voltage of 600 Vdc. The circuit breakers are suitable for use only with UPS (ungrounded uninterruptible power supplies systems).

This two-level voltage rating allows these circuit breakers to be applied to battery sources having a short-circuit availability of 20,000 amperes or 50,000 amperes for PowerPact H-, J-, and L-frame DC circuit breakers at 500 Vdc.

PowerPact H-frame DC circuit breakers have a fixed magnetic trip system. PowerPact J- and L-frame DC circuit breakers are provided with an adjustable magnetic trip that is readily accessible by means of a single adjustment on the face of the circuit breaker.

PowerPact H- and J-frame circuit breakers are UL Listed for the interrupting ratings shown only if applied with three poles connected in series (series connection is external to circuit breaker). (See figure for example of diagram.)

PowerPact L-frame circuit breakers are UL Listed for the interrupting ratings shown with two or three poles connected in series (series connection is external to circuit breaker).

**NOTE:** Due to external series connection, I-Line™ circuit breakers are not available for this application.

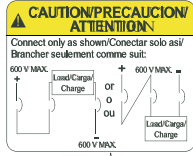

Connection Diagram

Table 7.92: Termination Options

Termination Letter	Termination Option
L	Lugs Both Ends
F	No Lugs (bus bar connection)
S	Rear Connection

JGL37125D81—Place termination letter in third block of circuit breaker catalog number.

Table 7.93: DC Molded Case Circuit Breakers

Ampere Rating	Circuit Breaker Cat. No.	Fixed Magnetic Trip —DC Amperes	Adjustable Magnetic Trip Range—DC Amperes [1]		Interrupting Rating @ 500 Vdc	
			Low	High		
30 A	HGL37030D87	450	—	—	20 k AIR	
50 A	HGL37050D87	450	—	—		
70 A	HGL37070D87	450	—	—		
100 A	JGL37100D81	—	400	600	20 k AIR	
125 A	JGL37125D81	—	400	600		
150 A	JGL37150D81	—	400	600		
175 A	JGL37175D81	—	400	600		
200 A	JGL37200D82	—	500	850		
225 A	JGL37225D82	—	500	850		
250 A	JGL37250D82	—	500	850	20 k AIR	
300 A	LGL37030D27	—	750	1500		
350 A	LGL37035D29	—	875	1750		
400 A	LGL37040D30	—	1000	2000	20 k AIR	
450 A	LGL37045D31	—	1125	2250		
500 A	LGL37050D32	—	1250	2500		
600 A	LGL37060D33	—	1500	3000		
700 A	LGL47070D35	—	1750	3500		
800 A	LGL47080D36	—	2000	4000		
900 A	LGL47090D86	—	2250	4500		
1000 A	LGL47100D40	—	2500	5000		
1200 A	LGL47120D42	—	3000	6000		
30A	HLL37030D87	450	—	—		50 k AIR
50A	HLL37050D87	450	—	—		
70A	HLL37070D87	450	—	—		
100A	JLL37100D81	—	400	600	50 k AIR	
125A	JLL37125D81	—	400	600		
150A	JLL37150D81	—	400	600		
175A	JLL37175D81	—	400	600		
200A	JLL37200D82	—	500	850		
225A	JLL37225D82	—	500	850		
250A	JLL37250D82	—	500	850	50 k AIR	
300A	LLL37030D27	—	750	1500		
350A	LLL37035D29	—	875	1750		
400A	LLL37040D30	—	1000	2000		
450 A	LLL36045D31	—	1125	2250		
500 A	LLL37050D32	—	1250	2500		
600 A	LLL37060D33	—	1500	3000		
700 A	LLL47070D35	—	1750	3500		
800 A	LLL47080D36	—	2000	4000		
900 A	LLL47090D86	—	2250	4500		
1000 A	LLL47100D40	—	2500	5000		
1200 A	LLL47120D42	—	3000	6000		

Accessories see page 7-54 and Supplemental Digest Section 3  
 Optional Lugs see page 7-59 and Supplemental Digest Section 3  
 Dimensions see page 7-75 and Supplemental Digest Section 3  
 Enclosures see page 7-80

[1] Magnetic trip tolerances are -20%/+30% from the nominal values shown.



Masterpact NW DC Circuit Breaker

**500 Vdc Masterpact NW Circuit Breakers**

**Table 7.94: Masterpact NW DC Circuit Breakers**

Ampere Rating	Circuit Breaker Reference No.	Interrupting Rating 500 Vdc (max 600 Vdc unloaded)
800 A	NW08NDC	35 kA
1000 A	NW10NDC	35 kA
1200 A	NW12NDC	35 kA
1400 A	NW14NDC	35 kA
1600 A	NW16NDC	35 kA
2000A	NW20NDC	35 kA
2500 A	NW25NDC	35 kA
3000 A	NW30NDC	35 kA
4000 A	NW40NDC	35 kA
800 A	NW08HDC	85 kA
1000 A	NW10HDC	85 kA
1200 A	NW12HDC	85 kA
1400 A	NW14HDC	85 kA
1600 A	NW16HDC	85 kA
2000A	NW20HDC	85 kA
2500 A	NW25HDC	85 kA
3000 A	NW30HDC	85 kA
4000 A	NW40HDC	85 kA



**Mission Critical Circuit Breakers**

Designed for selectively coordinated systems, mission critical circuit breakers maximize continuity of the electrical service by allowing the branch circuit breaker to clear the fault.

Mission critical circuit breakers are engineered with technology that optimizes current, time and energy selectivity so the fault is cleared by the circuit breaker immediately upstream of the occurrence. This technology (see figure below) allows the remaining areas of the electrical system to continue operation without disruption. In addition to unique design attributes, Square D mission critical circuit breakers have also undergone rigorous testing procedures to certify the coordination with downstream circuit breakers —combining innovative engineering with validated test results.

Apply Square D mission critical circuit breakers in emergency power distribution systems, data centers, hospitals or anywhere continuity of service is desired.

The PowerPact™ J- and L-Frame Mission Critical circuit breakers deliver high levels of selective coordination in a flexible design that can be easily configured for a variety of applications. Tested to be selectively coordinated with the QO™ family of miniature circuit breakers and the ED, EG, and EJ circuit breakers, this solution provides peace of mind when power availability is critical.

An electronic trip unit provides adjustable long-time settings in four sensor sizes, allowing coverage from 70 A through 600 A on a 120–240, 208Y/120, 240, 480Y/277, and 480 V systems.

**PowerPact Circuit Breakers with Micrologic Electronic Trip Units**

The advantages of being able to adjust the trip curve of a circuit breaker equipped with an electronic trip system are obvious. There are other advantages, such as being able to adjust or turn off the instantaneous trip function on some circuit breakers and models of trip units.

**Table 7.95: PowerPact J- and L-Frame Mission Critical Circuit Breakers**

Ratings	Available Configurations
UL 489 Listed CSA Certified Voltage: 480 V	I-Line mounting Main circuit breaker in NQ and NF panelboards Unit mount for OEM users Plug-in base for OEM users Drawout base for OEM users

**Table 7.96: J-Frame 250 A Electronic Trip Mission Critical 100% Rated Circuit Breakers (480/277 Vac) with Factory Sealed Trip Units Suitable for Reverse Connection**

Electronic Trip Unit Type	Trip Function	Trip Unit	Continuous Current	Cat. No.				Terminal
				D Interrupting	G Interrupting	J Interrupting	L Interrupting	
Standard	LI	3.2 W	250 A	JDL34250WU31X	JGL34250WU31X	JJL34250WU31X	JLL34250WU31X	AL250JD [1]
Standard	LSI	3.2S-W	250 A	JDL34250WU33X	JGL34250WU33X	JJL34250WU33X	JLL34250WU33X	AL250JD [1]
High Perf. Ammeter	LSI	5.2A-W	250 A	JDL34250WU43X	JGL34250WU43X	JJL34250WU43X	JLL34250WU43X	AL250JD [1]
High Perf. Energy	LSI	5.2E-W	250 A	JDL34250WU53X	JGL34250WU53X	JJL34250WU53X	JLL34250WU53X	AL250JD [1]
High Perf. Ammeter	LSIG	6.2A-W	250 A	JDL34250WU44X	JGL34250WU44X	JJL34250WU44X	JLL34250WU44X	AL250JD [1]
High Perf. Energy	LSIG	6.2E-W	250 A	JDL34250WU54X	JGL34250WU54X	JJL34250WU54X	JLL34250WU54X	AL250JD [1]

**Table 7.97: J-Frame Termination Options**

Termination Letter	
A = I-Line (See Section 9)	J G L 3 6 1 0 0
F = No Lugs (includes terminal nut kit on both ends)[2]	For factory-installed termination, place termination letter in the third block of the circuit breaker catalog number.
L = Lugs both ends	Termination Letter
M = Lugs ON end Terminal Nut Kit OFF end	
P = Lugs OFF end Terminal Nut Kit ON end	
N = Plug-in	
D = Drawout	
S = Rear Connected	

**Table 7.98: J-Frame Interrupting Ratings**

Voltage	Interrupting Rating			
	D	G	J	L
240 Vac	25 kA	65 kA	100 kA	125 kA
480 Vac	18 kA	35 kA	65 kA	100 kA

[1] AL250JD terminal wire range is (1) 3/0 AWG–350 kcmil Al or Cu.

[2] Add TS suffix for circuit breaker without terminal nut kit.

**Table 7.99: L-Frame 600 A Electronic Trip Mission Critical Circuit Breakers (480/277 Vac) with Factory Sealed Trip Units Suitable for Reverse Connection [3]**

Electronic Trip Unit Type	Trip Function	Trip Unit	Continuous Current	Cat. No.				Terminal
				D Interrupting	G Interrupting	J Interrupting	L Interrupting.	
<b>480/277 Vac, 50/60 Hz, 3P</b>								
Standard	LI	3.3 W	250 A	LDL34250WU31X	LGL34250WU31X	LJL34250WU31X	LLL34250WU31X	AL400L61K3 [4]
			400 A	LDL34400WU31X	LGL34400WU31X	LJL34400WU31X	LLL34400WU31X	AL600LS52K3 [5]
			600 A	LDL34600WU31X	LGL34600WU31X	LJL34600WU31X	LLL34300WU31X	AL400L61K3 [4]
Standard	LSI	3.3S-W	250 A	LDL34250WU33X	LGL34250WU33X	LJL34250WU33X	LLL34250WU33X	AL400L61K3 [4]
			400 A	LDL34400WU33X	LGL34400WU33X	LJL34400WU33X	LLL34400WU33X	AL600LS52K3 [5]
			600 A	LDL34600WU33X	LGL34600WU33X	LJL34600WU33X	LLL34300WU33X	AL600LS52K3 [5]
High Perf. Ammeter	LSI	5.3A-W	400 A	LDL34400WU43X	LGL34400WU43X	LJL34400WU43X	LLL34400WU43X	AL600LS52K3 [5]
			600 A	LDL34600WU43X	LGL34600WU43X	LJL34600WU43X	LLL34300WU43X	AL600LS52K3 [5]
			400 A	LDL34400WU53X	LGL34400WU53X	LJL34400WU53X	LLL34400WU53X	AL600LS52K3 [5]
High Perf. Energy	LSI	5.3E-W	600 A	LDL34600WU53X	LGL34600WU53X	LJL34600WU53X	LLL34300WU53X	AL600LS52K3 [5]
			400 A	LDL34400WU44X	LGL34400WU44X	LJL34400WU44X	LLL34400WU44X	AL600LS52K3 [5]
			600 A	LDL34600WU44X	LGL34600WU44X	LJL34600WU44X	LLL34300WU44X	AL600LS52K3 [5]
High Perf. Ammeter	LSIG	6.3A-W	400 A	LDL34400WU54X	LGL34400WU54X	LJL34400WU54X	LLL34400WU54X	AL600LS52K3 [5]
			600 A	LDL34600WU54X	LGL34600WU54X	LJL34600WU54X	LLL34300WU54X	AL600LS52K3 [5]
			400 A	LDL34400WU44X	LGL34400WU44X	LJL34400WU44X	LLL34400WU44X	AL600LS52K3 [5]
High Perf. Energy	LSIG	6.3E-W	600 A	LDL34600WU44X	LGL34600WU44X	LJL34600WU44X	LLL34300WU44X	AL600LS52K3 [5]
			400 A	LDL34400WU54X	LGL34400WU54X	LJL34400WU54X	LLL34400WU54X	AL600LS52K3 [5]
			600 A	LDL34600WU54X	LGL34600WU54X	LJL34600WU54X	LLL34300WU54X	AL600LS52K3 [5]
<b>480/277 Vac, 50/60 Hz, 4P</b>								
Standard	LI	3.3 W	250 A	LDL44250WU31X	LGL44250WU31X	LJL44250WU31X	LLL44250WU31X	AL400L61K4 [4]
			400 A	LDL44400WU31X	LGL44400WU31X	LJL44400WU31X	LLL44400WU31X	AL600LS52K4 [5]
			600 A	LDL44600WU31X	LGL44600WU31X	LJL44600WU31X	LLL44300WU31X	AL400L61K4 [4]
Standard	LSI	3.3S-W	250 A	LDL44250WU33X	LGL44250WU33X	LJL44250WU33X	LLL44250WU33X	AL400L61K4 [4]
			400 A	LDL44400WU33X	LGL44400WU33X	LJL44400WU33X	LLL44400WU33X	AL600LS52K4 [5]
			600 A	LDL44600WU33X	LGL44600WU33X	LJL44600WU33X	LLL44300WU33X	AL600LS52K4 [5]
High Perf. Ammeter	LSI	5.3A-W	400 A	LDL44400WU43X	LGL44400WU43X	LJL44400WU43X	LLL44400WU43X	AL600LS52K4 [5]
			600 A	LDL44600WU43X	LGL44600WU43X	LJL44600WU43X	LLL44300WU43X	AL600LS52K4 [5]
			400 A	LDL44400WU53X	LGL44400WU53X	LJL44400WU53X	LLL44400WU53X	AL600LS52K3 [5]
High Perf. Energy	LSI	5.3E-W	600 A	LDL44600WU53X	LGL44600WU53X	LJL44600WU53X	LLL44300WU53X	AL600LS52K3 [5]
			400 A	LDL44400WU44X	LGL44400WU44X	LJL44400WU44X	LLL44400WU44X	AL600LS52K4 [5]
			600 A	LDL44600WU44X	LGL44600WU44X	LJL44600WU44X	LLL44300WU44X	AL600LS52K4 [5]
High Perf. Ammeter	LSIG	6.3A-W	400 A	LDL44400WU54X	LGL44400WU54X	LJL44400WU54X	LLL44400WU54X	AL600LS52K4 [5]
			600 A	LDL44600WU54X	LGL44600WU54X	LJL44600WU54X	LLL44300WU54X	AL600LS52K4 [5]
			400 A	LDL44400WU44X	LGL44400WU44X	LJL44400WU44X	LLL44400WU44X	AL600LS52K4 [5]
High Perf. Energy	LSIG	6.3E-W	600 A	LDL44600WU44X	LGL44600WU44X	LJL44600WU44X	LLL44300WU44X	AL600LS52K4 [5]
			400 A	LDL44400WU54X	LGL44400WU54X	LJL44400WU54X	LLL44400WU54X	AL600LS52K4 [5]
			600 A	LDL44600WU54X	LGL44600WU54X	LJL44600WU54X	LLL44300WU54X	AL600LS52K4 [5]

Accessories see page 7-54

Optional Lugs see page 7-59

Compression and PDC Lugs see Supplemental Digest, Section 3

Dimensions see page 7-75

Enclosures see page 7-76





[3] Standard rating (100%) for 250 A and 400 A only. Standard rating 80% for 600 A.

[4] AL400L61K3 terminal wire ranges are (1) #2 AWG–500 kcmil Al or (1) #2 AWG–600 kcmil Cu.

[5] AL600LS52K3 terminal wire ranges are (2) 2/0 AWG–500 kcmil Al or Cu.

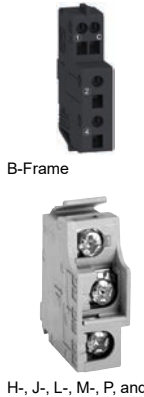
PowerPact Accessories

Table 7.100: Electrical Accessories

Accessory	Description	Rated Voltage	B-, H-, J-, and L-Frame					M-, P-, and R-Frame		
			Factory Installed Cat. Suffix	B-Frame		H- and J-Frame	L-Frame	Factory Installed Cat. Suffix	Field-Installable Cat. No.	
				Field-Installable Cat. No.	Field-Installable Pre-Wired Cat. No.	Field-Installable Cat. No.	Field-Installable Cat. No.			
 <p>Auxiliary and Alarm Switches (OF, SD, SDE)</p> <p>B-Frame</p> <p>H-, J-, L-, M-, P, and R-Frame</p>	<p>Provides circuit breaker contact status. Note: The location of the accessory in the circuit breaker determines its function.</p>	<p>Standard Min Load = 10mA with 24V</p> <p>Low Level Min Load = 1mA with 24V</p>	1 auxiliary switch (OF) 1a1b	AA	LV426950	LV426951	S29450	S29450	AA	S29450
			2 auxiliary switch (OF) 2a2b	AB	—	—	2x S29450	2x S29450	AB	2x S29450
			3 auxiliary switch (OF) 3a3b	AC	—	—	—	3x S29450	AC	3x S29450
			Alarm Switch (SD) 1a1b	BC	LV426950	LV426952	S29450	S29450	BC	S29450
			Overcurrent trip switch (SDE) 1a1b	BD	—	—	—	S29450	BD	S29450
			Consisting of:	OF Switch	—	—	S29450	—	—	—
				SDE Adapter	—	—	S29451	—	—	—
			Alarm switch and Overcurrent trip switch	BE	—	—	—	2x S29450	BE	2x S29450
			Consisting of:	OF Switch	—	—	2x S29450	—	—	—
				SDE Adapter	—	—	S29451	—	—	—
			Auxiliary Switch/Alarm Switch/Adapter (OF/SD/SDE) Kit	—	—	—	—	—	—	S33801 [1]
			One auxiliary switch (OF) 1a1b	AE	—	—	S29452	S29452	AE	S29452
			Two auxiliary switches (OF) 2a2b	AF	—	—	2x S29452	2x S29452	AF	2x S29452
			3 auxiliary switches (OF) 3a3b	AG	—	—	—	3x S29452	AG	3x S29452
			Alarm Switch (SD) 1a1b	BH	—	—	S29452	S29452	BH	S29452
Overcurrent trip switch (SDE) 1a1b	BJ	—	—	—	S29452	BJ [2]	S29452			
Consisting of:	OF Switch	—	—	S29452	—	—	—			
	SDE Adapter	—	—	S29451	—	—	—			
Alarm switch and Overcurrent trip switch	BK	—	—	—	2x S29452	BK [2]	2x S29452			
Consisting of:	OF Switch	—	—	2x S29452	—	—	—			
	SDE Adapter [3]	—	—	S29451	—	—	—			
 <p>Shunt Trip (MX)</p> <p>B-Frame</p> <p>H-, J-, and L-Frame</p>	<p>Trips the circuit breaker from a remote location by means of a trip coil energized from a separate supply voltage circuit.</p>	<p>AC</p> <p>DC</p>	24	SK	LV426841	LV426861	S29384	S29384	SK	S33659
			48	SL	LV426842	LV426862	S29385	S29385	SL	S33660
			110-130	SA	LV426843	LV426863	S29386	S29386	SA	S33661
			220-240	SD, SF	—	—	—	—	SC	S33662
			208-277	SD	LV426844	LV426864	S29387	S29387	SD	S33663
			380-480	SH	LV426846	LV426866	S29388	S29388	SH	S33664
			525-600	SJ	—	—	S29389	S29389	—	—
			12	SN	—	—	S29382	S29382	SN	S33658
			24	SO	LV426841	LV426861	S29390	S29390	SO	S33659
			30	SU	—	—	S29391	S29391	SU	S33659
			48	SP	LV426842	LV426862	S29392	S29392	SP	S33660
			60	SV	—	—	S29383	S29383	SV	S33660
			125	SR	LV426843	LV426863	S29393	S29393	SR	S33661
			250	SS	LV426844	LV426864	S29394	S29394	SS	S33662
			 <p>Undervoltage Trip (MN)</p> <p>H-, J-, and L-Frame</p>	<p>Instantaneously opens the circuit breaker when the under-voltage trip supply voltage drops to a value between 35% and 70% of its rated voltage. Closing is allowed when the supply voltage of the undervoltage trip reaches 85% of rated voltage.</p>	<p>AC</p> <p>DC</p>	24	UK	LV426801	LV426821	S29404
48	UL	LV426802				LV426822	S29405	S29405	UL	S33669
110-130	UA	LV426803				LV426823	S29406	S29406	UA	S33670
220-240	UC	LV426804				LV426824	—	—	UC	S33671
208-277	UD	LV426805				LV426825	S29407	S29407	—	—
380-415	UF	LV426806				LV426826	—	—	—	—
380-480	UH	LV426807				LV426827	S29408	S29408	UH	S33673
525-600	UJ	—				—	S29409	S29409	—	—
12	UN	—				—	S29402	S29402	—	—
24	UO	LV426801				LV426821	S29410	S29410	UO	S33668
30	UU	—				—	S29411	S29411	UU	S33668
48	UP	LV426802				LV426822	S29412	S29412	UP	S33669
60	UV	—				—	S29403	S29403	UV	S33669
125	UR	LV426803				LV426823	S29413	S29413	UR	S33670
250	US	LV426815				LV426835	S29414	S29414	US	S33671
 <p>Time Delay Unit</p>	<p>Undervoltage trip with externally mounted adjustable time delay unit for UVR of 0.5, 0.9, 1.5, 3.0 seconds before circuit breaker trips</p> <p>Undervoltage trip with externally mounted non-adjustable time delay unit of 0.25 sec before circuit breaker trips.</p>	AC/DC	48	—	S33680 [4]	—	S33680 [4]	S33680 [4]	—	S33680 [4]
			100-130	—	S33681 [4]	—	S33681 [4]	S33681 [4]	—	S33681 [4]
			220-250	—	S33682 [4]	—	S33682 [4]	S33682 [4]	—	S33682 [4]
			380-480	—	—	—	—	—	—	S33683 [4]
		AC/DC	48	—	S29426 [4]	—	S29426 [4]	S29426 [4]	—	—
			100-130	—	—	—	—	—	—	S33684 [4]
			200-250	—	—	—	—	—	—	S33685 [4]
			220-240	—	S29427 [4]	—	S29427 [4]	S29427 [4]	—	—

[1] P-frame drawout circuit breaker only.  
 [2] Not available on electrically operated P-frame.  
 [3] SDE Adapter used for H- and J-frame only.  
 [4] Field-installable kit includes time delay module only. Order undervoltage trip separately.

7 MINIATURE AND MOLDED CASE CIRCUIT BREAKERS

**Motors and Rotary Handles**

**Table 7.101: Motor Operators for H-, J-, and L-Frame Circuit Breakers**

Description	Rated Voltage	Factory Installed Cat. No. Suffix	Field-Installable Kit			
			H-Frame [5] Cat. No.	J-Frame Cat. No.	L-Frame 600 A Cat. No.	
 <p>Motor Operator</p> <p>Standard motor for electrically-operated circuit breakers [6]</p>	AC	48-60	ML	S29440	S31548	S432639
		110-130	MA	S29433	S31540	S432640
		208-277	MD	S29434	S31541	S432641
		220-240	MF	—	—	S432642
		380-415	MH	S29435	S31542	S432647
	DC	24-30	MO	S29436	S31543	S432643
		48-60	MV	S29437	S31544	S432644
		110-130	MR	S29438	S31545	S432645
		250	MS	S29439	S31546	S432646
	Communicating motor for electrically-operated circuit breakers [7]	AC	220-240	NC	S429441	S431549
Locking device	Mounting hardware		—	—	—	S32649
	Ronis lock		—	S41940	S41940	S41940
	Profalux lock		—	S42888	S42888	S42888
Operations counter	Mounting hardware plus Ronis lock		—	S429449	S429449	—
			—	—	—	S32648
Adapter for I-Line circuit breaker			—	S37420	S37420	—

**Table 7.102: Spring-Charging Motors for Electrically-Operated P-Frame Circuit Breakers**

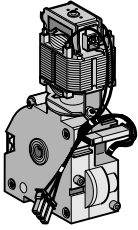
Description	Rated Voltage	Factory Installed Cat. No. Suffix	P-Frame (For Field Replacement Only) Spring Charging Motor Cat. No.	Replacement Coils Opening/Closing Coil Cat. No.	
 <p>Spring-Charging Motor</p> <p>Standard motor for electrically-operated circuit breakers. Factory-installed includes motor and opening/closing coils.</p>	AC	48	ML	S47391	S33660
		100-130	MA	S47395	S33661
		220-240	MC	S47396	S33662
		380-415	MF	S47398	S33664
		24-30	MO	S47390	S33659
	DC	48-60	MV	S47391	S33660
		110-130	MR	S47392	S33661
		200-250	MS	S47393	S33662
		48	NL	S47391	S33034
		100-130	NA	S47395	S33035
Communicating motor mechanism for electrically-operated circuit breakers. Factory-installed includes motor and opening/closing coils.	AC	220-240	NC	S47396	S33036
		380-415	NF	S47398	S33038
		24-30	NO	S47390	S33033
		48-60	NV	S47391	S33034
	DC	110-130	NR	S47392	S33035
		200-250	NS	S47393	S33036

[5] Not available in H-frame 2P modules.

[6] Factory and field-installed standard motor operators for H- and J-frame circuit breakers require the SDE switch and SDE adapter (both included).

[7] Factory and field-installed standard motor operators for L-frame circuit breakers require the SDE switch (included).

[7] Installation requires BSCM with NSX Cord. For ordering information see page 7-68.

Rotary Handles

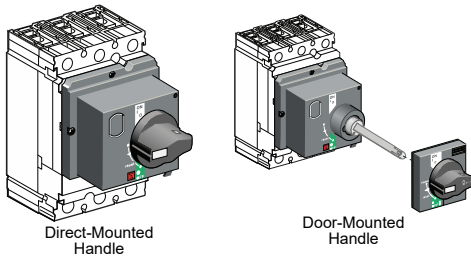
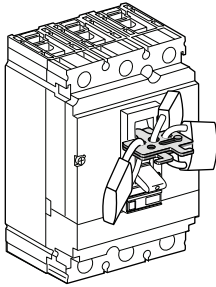

Table 7.103: Rotary Operated Handles

Device	Description	B-Frame		H- and J-Frame [8]		L-Frame		P-Frame	
		Factory Installed Cat. No. Suffix	Field-Installable Cat. No.	Factory Installed Cat. No. Suffix	Field-Installable Cat. No.	Factory Installed Cat. No. Suffix	Field-Installable Cat. No.	Factory Installed Cat. No. Suffix	
Direct Mounted	Standard black handle	Operating mechanism kit	RD10	LV426930	RD10	S29337	RD10	S32597	RD10
	Standard black handle with	Two early-break and two early make switches	—	—	—	—	—	—	RD16
		One early-break switch	—	—	RD12	S29337 + S29345	RD12	S32597 + S32605	—
		Two early-make switches	—	—	RD13	S29337 + S29346	RD13	S32597 + S29346	—
	Red handle on yellow bezel	Operating mechanism kit	RD20	LV426931	RD20	S29339	RD20	S32599	—
		One early-break switch	—	—	RD22	S29339 + S29345	RD22	S32599 + S32605	—
		Two early-make switches	—	—	RD23	S29339 + S29346	RD23	S32599 + S29346	—
	MCC conversion accessory		—	—	—	S429341	—	S32606	—
	CNOMO conversion accessory		—	—	—	29342	—	S32602	—
	Door Mounted	Standard black handle	Operating mechanism kit	—	LV426932	RE10	S29338	RE10	S32598
Standard black handle with:		Two early-break and two early make switches	—	—	—	—	—	—	RE16
		Two early make switches	—	—	RE13	S29338 + S29346	RE13	S32598 + S29346	—
Red handle on yellow bezel	Operating mechanism kit	—	LV426933	RE20	S29340	RE20	S32600	—	
Rotary Handle Replacement Kit		—	—	—	—	—	—	S33875	
Telescoping		—	—	RT10	S29343	RT10	S32603	—	
Accessories	Key lock adapter	—	—	—	S429344	—	S32604	—	
	Key locks	Ronis 1351.500	—	—	—	S41940	—	S41940	—
		Profalux KS5 B24 D4Z	—	—	—	S42888	—	S42888	—
		2 Ronis keylocks with 1 key	—	—	—	S41950	—	S41950	—
		2 Profalux keylocks with 1 key	—	—	—	S42878	—	S42878	—
	Indication Auxiliary Switch	One early-break switch	—	—	—	S29445	—	S32605	—
Two early-make switches		—	—	—	S29346	—	S29346	—	

[8] Not available in H-frame 2P modules.

Locks, Installation Accessories, and Rear Connectors



Removable Padlock Attachment

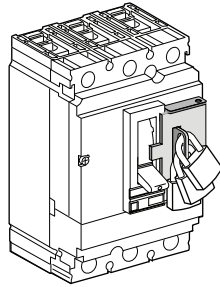

Fixed Padlock Attachment

Table 7.104: Locks, Interlocking

Device	Description	B-Frame		H- and J-Frame		Q-Frame		L-Frame	M- and P-Frame		R-Frame		
		Factory-Installed Cat. No. Suffix	Field-Installable Cat. No.	Factory-Installed Cat. No. Suffix	Field-Installable Cat. No.	Factory-Installed Cat. No. Suffix	Field-Installed Cat. No.	Field-Installable Cat. No.	Factory-Installed Cat. No. Suffix	Field-Installable Cat. No.	Factory-Installed Cat. No. Suffix	Field-Installable Cat. No.	
Handle Padlocking Device	Removable (lock OFF only)	—	S29370	—	S29370	—	—	S29370	—	S44936	—	S33996	
	Fixed (lock OFF or ON)	YP	LV426905 LV426907 (I-Line)	YP	S29371	YP	QBPA	S32631	YP	S32631	YP	S32631	
	Fixed (lock OFF only) <sup>[9]</sup>	YQ	LV426906 LV426908 (I-Line)	YQ	S37422	YQ	QBPAF	NJPAF	YQ	MPRPAF	YQ	MPRPAF	
	Fixed (lock OFF only)–2P	—	—	YQ	H2PHLA	YQ	—	—	—	—	—	—	
Interlocking (Not UL listed)	Mechanical for circuit breakers with rotary handles <sup>[10]</sup>	—	—	—	S29369	—	—	S32621	—	S33890	—	—	
	Mechanical for circuit breakers with toggles <sup>[10]</sup>	—	LV426994	—	S29354	—	QBMIK	S32614	—	—	—	—	
Key Locking	Provision only, vertical mount, 1 or 2 locks	Kirk	—	—	—	—	—	—	JA	—	—	—	
	Provisions only, vertical mounting one key interlock including padlock provision, open position only.	Kirk	—	—	—	—	—	—	JE <sup>[11]</sup> <sup>[12]</sup>	—	JE <sup>[12]</sup>	—	
	Provision only, horizontal mount 1 lock, M- and P-frame 1 or 2 locks, R-frame	Kirk	—	—	—	—	—	—	—	JK	—	JK	—
		Ronis	—	—	—	—	—	—	—	JB <sup>[13]</sup>	—	JB	—
		Profalux	—	—	—	—	—	—	—	JD <sup>[13]</sup>	—	JD	—
	Provision and 1 lock, vertical mount	Kirk	—	—	—	—	—	—	—	JG	—	—	—
		Kirk	—	—	—	—	—	—	—	JL	—	JL	—
		Ronis	—	—	—	—	—	—	—	JC <sup>[13]</sup>	—	JC	—
	Provision and 1 lock, horizontal mount	Ronis	—	—	—	—	—	—	—	JF <sup>[13]</sup>	—	JF	—
Profalux		—	—	—	—	—	—	—	JF <sup>[13]</sup>	—	JF	—	
Provision and 2 locks keyed alike	Kirk	—	—	—	—	—	—	—	JN	—	JN	—	
Provision and 2 locks keyed differently	Kirk	—	—	—	—	—	—	—	JP	—	JP	—	

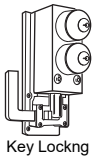

Key Locking

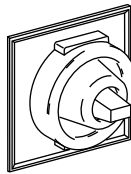

Handle Rubber Boot

Table 7.105: Installation Accessories for B-, H-, J-, and L-Frame Circuit Breakers

Description	Field-Installable Cat. No.		
	B-Frame	H- and J-Frame	L-Frame
Front Panel Escutcheon for Toggle Breakers	—	S29315	32556
Front Panel Escutcheon for Rotary Handle, Motor Operator, or extended escutcheon	—	S29317	S32558
Phase Barriers (set of 6)	LV426920	S29329	32570
Handle Rubber Boot <sup>[14]</sup>	—	S29319	S32560
Sealing Accessories (for front cover screws)	S29375	S29375	S29375
DIN rail mounting kit (requires 15 mm depth on a 35 mm DIN rail) <sup>[14]</sup>	Standard	S29305	—
DIN rail adapter	Standard	—	—
Handle Extensions (set of 5)	—	S29313	S432553
Rear Insulation Kit (2P)	LV426921	—	—
Rear Insulation Kit (3P)	LV426922	—	—
Rear Insulation Kit (4P)	LV426923	—	—
Terminal Extensions-Spreaders (3P)	LV426940	—	—
Terminal Extensions-Spreaders (4P)	LV426941	—	—
5 N-m Torque Limiting Bit, Set of 6	LV426992	—	—
5 N-m Torque Limiting Bit, Set of 8	LV426993	—	—
9 N-m Torque Limiting Bit, Set of 6	LV426990	—	—
9 N-m Torque Limiting Bit, Set of 8	LV426991	—	—

[9] Not available on HD and HG 2P modules.  
 [10] Not available in M frame or HD and HG 2P modules.  
 [11] Not available on M-frame.  
 [12] Not available on I-Line.  
 [13] Not available for M, P or P frame drawout. Only available on P frame electronic.  
 [14] Not available in HD and HG 2P modules.

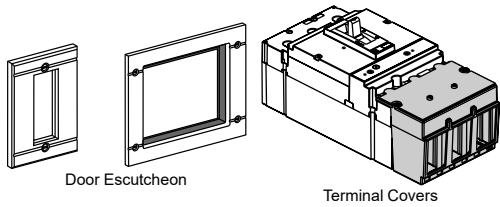



Table 7.106: Installation Accessories for M-, P-, and R-Frame Circuit Breakers

Description		Frame	Field-Installable Cat. No.
Door Escutcheon	Accessory Cover	M-, P-Frame	S33718
		R-Frame	S33929
	Toggle Handle	M-, P-Frame	S33717
	Drawout	P-Frame	S33857
Terminal Covers	Short lug cover 3P	P-Frame	S33932
	Short lug cover 4P		S33933
	Long lug cover 3P		S33934
	Long lug cover 4P		S33935
Replacement Handle	Standard	R-Frame	S33997
	Standard Short	M-, P-Frame	S46998
	Long	M-, P-Frame	S46996

Table 7.107: Rear Connections

Device	Description	H-Frame			J-Frame			L-Frame			
		Poles	Factory-Installed Termination No.	Field-Installable Cat. No.	Poles	Factory-Installed Termination No.	Field-Installable Cat. No.	Poles	Factory-Installed Termination No.	Field-Installable Cat. No.	
 Rear Connection	Mixed Rear Connection Kit [15]	2	S	—	2	S	—	3	S	S32477	
		3	S	S37432	3	S	S37437	4	S	S32478	
	Consisting of:	Short rear connections (set of 2)	2 or 3	—	2x S37433	2 or 3	—	2x S37438	3	—	2-x S432475
		Long rear connections (set of 2)		—	S37434		—	S37439 [16]			—
		Short terminal cover (3P)	3	—	S37436	3	—	S37440	3	—	2-x S32562
Short terminal cover (4P)	4	—	—	—	—	—	4	—	2-x S32563		

[15] Kit contains 4 short rear connections, 2 long rear connections (4 long rear connections for 4P), hardware, and 2 terminal covers.  
 [16] For use with 3P circuit breakers only.

**Mechanical Lugs**

**Table 7.108: Mechanical Lug Kits for B-Frame Circuit Breakers [17]**

Description	Circuit Breaker Application			Ampere Rating	Number of Wires Per Lug and Wire Range	Factory-Installed Cat. Suffix	Field-Installable Cat. No.	Qty Per Kit
	Standard	Ampere Rating	Optional					
Al Lugs for Use with Al or Cu Wire			BD BG BJ	15-125 A	(1) 14-2/0 AWG Al or Cu	LH	LV426988	2
			BD BG BJ	15-125 A	(1) 14-2/0 AWG Al or Cu	LH	LV426989	3
Cu Lugs for Use with Cu Wire Only			BD BG BJ	15-125 A	(1) 14-1/0 AWG Cu	LC	LV426986	2
			BD BG BJ	15-125 A	(1) 14-1/0 AWG Cu	LC	LV426987	3
EverLink Lug	BD BG BJ (1P)	15 - 125 A			(1) 14-3/0 AWG Cu	—	LV426972	1
	BD BG BJ (2P)	15 - 125 A			(1) 14-3/0 AWG Cu	—	—	—
	BD BG BJ (3P)	15 - 125 A			(1) 14-3/0 AWG Cu	—	—	—
	BD BG BJ (4P)	15 - 125 A			(1) 14-3/0 AWG Cu	—	—	—
EverLink Lug with Control Wire Terminal		15 - 125 A	BD BG BJ (2P)		(1) 14-3/0 AWG Cu	LU, LV, or LW [18]	LV426973	1
		15 - 125 A	BD BG BJ (3P)		(1) 14-3/0 AWG Cu	LU, LV, or LW [18]	LV426974	1
		15 - 125 A	BD BG BJ (4P)		(1) 14-3/0 AWG Cu	LU, LV, or LW [18]	LV426975	1

**Table 7.109: Mechanical Lug Kits for H- and J-Frame Circuit Breakers [17]**

Description	Circuit Breaker Application			Ampere Rating	Number of Wires Per Lug and Wire Range	Kit Cat. No.	Qty Per Kit
	Standard	Ampere Rating	Optional				
Al Lugs for Use with Al or Cu Wire	HD, HG, HJ, HL	15–150 A			(1) 14–3/0 AWG Al or Cu	AL150HD	3
	JD, JG, JJ, JL	150–175 A			(1) 4-4/0 AWG Al or Cu	AL175JD	3
	JD, JG, JJ, JL	200–250 A	JD, JG, JJ, JL	150–175 A	(1) 3/0–350 kcmil Al or Cu	AL250JD	3
Cu Lugs for Use with Cu Wire Only			HD, HG, HJ, HL	15–150 A	(1) 14–2/0 AWG Cu	CU150HD	3
			JD, JG, JJ, JL	150–250 A	(1) 1/0–300 kcmil Cu	CU250JD	3
	Control Wire Terminal for H-frame lug kit					S37423	2
	Control Wire Terminal for J-frame lug kit					S37424	2

**Table 7.110: Mechanical Lug Kits for L-Frame Circuit Breakers [19]**

Description	Circuit Breaker Application				Number of Wires Per Lug and Wire Range	Kit Cat. No.	Qty Per Kit
	Ampere Rating	Poles	Unit Mount	I-Line			
Al Lugs for Use with Al or Cu Wire	250	3	X	X	(1) 2 AWG–500 kcmil Al	AL400L61K3	3
		4	X	—	(1) 2 AWG–600 kcmil Cu	AL400L61K4	4
	400/600	3	X	—	(2) 2/0 AWG–500 kcmil Al or Cu	AL600LS52K3	3
		4	X	—	(2) 2/0 AWG–500 kcmil Al or Cu	AL600LS52K4	4
Cu Lugs for Use with Cu Wire Only	400/600	3	X	X	(2) 3/0 AWG–500 kcmil Al or Cu	AL600LF52K3	3
		250	3	X	X	(1) 2 AWG–600 kcmil Cu	CU400L61K3
	400/600	4	X	—	(2) 2/0 AWG–500 kcmil Cu	CU400L61K4	4
		3	X	—	(2) 2/0 AWG–500 kcmil Cu	CU600LS52K3	3
400/600	4	X	—	(2) 2/0 AWG–500 kcmil Cu	CU600LS52K4	4	
	3	X	X	(2) 3/0 AWG–500 kcmil Cu	CU600LF52K3	3	

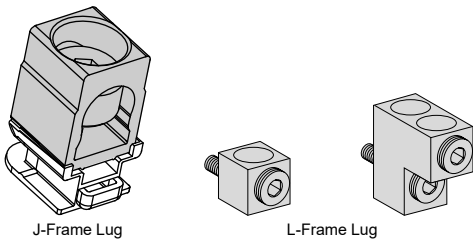

**Table 7.111: Mechanical Lug Kits for M-, P- and R-Frame Circuit Breakers [20]**

Description	Circuit Breaker Application				Wires per Lug and Wire Range	Cat. No.	Lugs Per Kit
	Standard	Rating	Optional	Rating			
Al Lugs for AL or Cu Wire	M-Frame, P-Frame	800 A	—	800 A	(3) 3/0 AWG-500 kcmil	AL800M23K	3
		1200 A	MG, MJ, PG, PJ, PK, PL	800 A	(4) 3/0 AWG-500 kcmil	AL1200P24K [21]	1
		—	MG, MJ, PG, PJ, PK, PL	800 A	(2) 3/0 AWG-600 kcmil	AL800P6K [21]	3
		—	MG, MJ, PG, PJ, PK, PL	800 A	(2) 3/0 AWG-750 kcmil	AL800P6K4 [21]	4
		—	MG, MJ, PG, PJ, PK, PL	800 A	(2) 3/0 AWG-750 kcmil 750 kcmil: compact AL only	AL800P7K [21]	3
		—	MG, MJ, PG, PJ, PK, PL	800 A	(2) 3/0 AWG-750 kcmil 750 kcmil: compact AL only	AL800P7K4 [21]	4
	P-Frame	1200 A	PG, PJ, PK, PL	800 A	(4) 3/0 AWG-500 kcmil	AL1200P25K [22]	3
		—	PG, PJ, PK, PL	800–1200 A	(3) 350-600 kcmil	AL1200P25K4 [22]	4
		—	PG, PJ, PK, PL	800–1200 A	(3) 350-600 kcmil	AL1200P6KU [22]	3
		—	PG, PJ, PK, PL	800–1200 A	(3) 350-600 kcmil	AL1200P6KU4 [22]	4
R-Frame	1200 A	I-Line	—	(4) 3/0 AWG-600 kcmil	AL1200R53K	1	
	2500 A	Unit Mount	—	(1) 3/0 AWG-750 kcmil	AL2500RK [23]	2	
Cu Lugs for Cu Wire Only [24]	M-Frame, P-Frame	—	PJ	100–150 A	(1) 1-1/0 AWG	CU250P1K [25]	3
		800 A	MG, MJ, PG, PJ, PK, PL	—	(3) 3/0 AWG-500 kcmil	CU800M23K	3
	1200 A	MG, MJ, PG, PJ, PK, PL	800–1200 A	(4) 3/0 AWG-500 kcmil	CU1200P24K [21]	1	
	P-Frame	1200 A	PG, PJ, PK, PL	800–1200 A	(4) 3/0 AWG-500 kcmil	CU1200P25K [22]	3
		1200 A	PG, PJ, PK, PL	800–1200 A	(4) 3/0 AWG-500 kcmil	CU1200P25K4	4
R-Frame	1200 A	I-Line	—	(4) 3/0 AWG-500 kcmil	CU1200R53K	1	

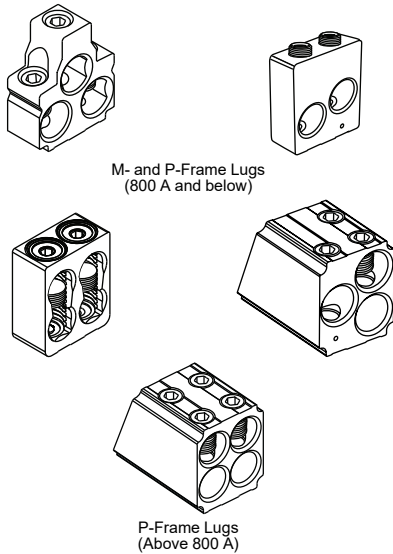

[17] For terminal nuts/bus bar connections see page 7-62.

[18] LU = ON end only, LV = OFF end only, LW = BOTH ends

[19] Lug kits for Legacy L-frame circuit breakers can be found in Supplemental Digest Section 11 (i.e. LA, LH circuit breakers).

[20] For lug with a tapped hole for control wire, add a "T" before the "K" in the catalog number (for example, AL800P6TK).

[21] Does not fit onto ON end of unit-mount P-frame circuit breakers.

[22] For unit-mount circuit breaker only.

[23] All unit-mount R-frame circuit breakers require terminal pads for mounting lugs of any type. See page 7-62.

[24] Not available with tapped hole for control wire.

[25] This lug can only be used on low amp PJ frame breakers where the Instantaneous setting must not be turned OFF. The cables must be laced with rope per lug instructions.

Compression Lugs

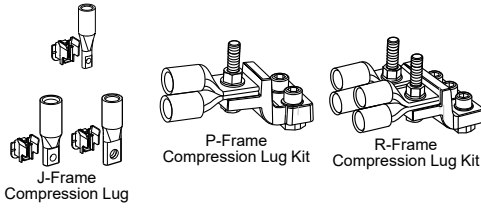

Table 7.112: Compression Lug Kits for PowerPact™ Circuit Breakers

Description	Circuit Breaker Type	Ampere Rating	System Range	Mounting Type	Dimension A (in)	Max. Lugs per Terminal	Cat. No.	Qty. Per Kit
<b>Compression Lug Kits for B-Frame Circuit Breakers</b>								
Aluminum Compression Lug Kits	B-frame	125 A	8-1/0 AWG Al or Cu	Unit	1.3	1	LV426988	2
		125 A	8-1/0 AWG Al or Cu		1.3	1	LV426989	3
Copper Compression Lug Kits	B-frame	125 A	6-1/0 AWG Cu		1.4	1	LV426986	2
		125 A	6-1/0 AWG Cu		1.4	1	LV426987	3
<b>Compression Lug Kits for H-Frame and J-Frame Circuit Breakers</b>								
Aluminum Compression Lug Kits	H-frame	60 A	6-2 AWG Al or Cu	Unit/I-line [26]	1.2	1	YA060HD	3
		150 A	1/0-4/0 AWG Al or Cu		2.5	1	YA150HD	3
	J-frame	150 A	1-3/0 AWG Al or Cu		1.2	1	YA150JD	3
		250 A	3/0-350 kcmil Al or Cu		2.5	1	YA250J35	3
Copper Compression Lug Kits	H-frame	60 A	6-1/0 AWG Cu		1.0	1	CYA060HD	3
		150 A	4-2/0 AWG Cu		1.2	1	CYA150HD	3
	J-frame	150 A	6-1/0 AWG Cu		0.7	1	CYA150JD	3
		250 A	2/0-300 kcmil Cu		1.1	1	CYA250J3	3
<b>Compression Lug Kits for L-Frame Circuit Breakers</b>								
Aluminum Compression Lug Kits	L-frame	250 A	4-300 kcmil Al/Cu	Unit/I-line [26]	1.2	1	YA400L31K3	3
		400 A	4-300 kcmil Al/Cu		2.5	2	YA600L32K3	6
		250 A	2/0-500 kcmil Al/Cu		1	1	YA400L51K3	3
		600 A	2/0-500 kcmil Al/Cu		2	2	YA600L52K3	6
		400 A	500-750 kcmil Al 500 kcmil Cu		1	1	YA400L71K3	3
		250 A	4-300 kcmil Al/Cu		1	1	YA400L31K4	4
		400 A	4-300 kcmil Al/Cu		2	2	YA600L32K4	8
		250 A	2/0-500 kcmil Al/Cu		1	1	YA400L51K4	4
		600 A	2/0-500 kcmil Al/Cu		1.2	2	YA600L52K4	8
		400 A	500-750 kcmil Al 500 kcmil Cu		2.5	1	YA400L71K4	4
Copper Compression Lug Kits	L-frame	250 A	2/0-300 kcmil Cu	Unit/I-line [26]	1.2	1	CYA400L31K3	3
		400 A	2/0-300 kcmil Cu		2.5	2	CYA600L32K3	6
		250 A	250-500 kcmil Cu		1	1	CYA400L51K3	3
		600 A	250-500 kcmil Cu		2	2	CYA600L52K3	6
		250 A	2/0-300 kcmil Cu		1	1	CYA400L31K4	4
		400 A	2/0-300 kcmil Cu		2	2	CYA600L32K4	8
		250 A	250-500 kcmil Cu		1	1	CYA400L51K4	4
		600 A	250-500 kcmil Cu		2	2	CYA600L52K4	8
<b>Compression Lug Kits for M-Frame, P-Frame, and R-Frame Circuit Breakers</b>								
Aluminum Compression Lug Kits	M-, P-frame	250 A	2/0-300 kcmil	Unit/I-line [26]	3.7	1	YA250P3	1
		300 A	4/0-500 kcmil		3.9	1	YA300P5	1
		400 A	2/0-300 kcmil		4.3	2	YA400P3	1
		400 A	500-750 kcmil		3.7	1	YA400P7	1
		600 A	4/0-500 kcmil		3.9	2	YA600P5	1
	R-frame[27]	800 A	500-750 kcmil	I-line [26]	4.3	2	YA800P7	1
		1200 A	2/0-300 kcmil		3.8	4	YA1200R3	1
		1200 A	4/0-500 kcmil		4.0	4	YA1200R5	1
		1200 A	500-750 kcmil		4.4	4	YA1200R7	1
		2000 A	2/0-300 kcmil		—[27]	8	YA2000R3	2
Copper Compression Lug Kits	M-, P-frame	2000 A	4/0-500 kcmil	Unit [26]	—[27]	8	YA2000R5	2
		2500 A	500-750 kcmil		—[27]	8 [28]	YA2500R7	1
		400 A	4/0-500 kcmil		3.3	1	CYA400P5	1
		600 A	4/0-500 kcmil		3.3	2	CYA600P5	1
		800 A	500-750 kcmil		3.6	2	CYA800P7	1
R-frame	1200 A	4/0-500 kcmil	I-Line [26]	3.5	4	CYA1200R5	1	
	1200 A	500-750 kcmil		3.8	4	CYA1200R7	1	

7 MINIATURE AND MOLDED CASE CIRCUIT BREAKERS

[26] Not for use on I-Line™ circuit breakers unless wire bending space is adequate.  
 [27] All unit-mount R-frame circuit breakers require terminal pads for mounting lugs of any type. See page 7-62.  
 [28] 9 lugs for 3000 A circuit breakers

**Power Distribution Connectors**

**Table 7.113: Power Distribution Connectors for B-Frame, H-Frame, J-Frame and L-Frame Circuit Breakers [29]**

Use with Circuit Breaker Type	Ampere Rating	(Wires Per Terminal) Wire Range	Dimension A (in.)	Cat. No.	Qty. Per Kit
BD, BG, BJ	125 A	(3) 14 - 2 AWG	1.2	PDC3BD2	3
	125 A	(6) 14 - 6 AWG	1	PDC6BD6	3
HD, HG, HJ, HL [30]	15-150 A	(6) 14-6 AWG Cu	1.0	PDC6HD6	3
	15-150 A	(3) 14-2 AWG Cu	1.2	PDC3HD2	3
JD, JG, JJ, JL [30]	150-250 A	(6) 14-4 AWG Cu	1.0	PDC6JD4	3
	150-250 A	(2) 14-1 AWG and (1) 3-2/0 AWG Cu	1.5	PDC3JD20	3
LD, LG, LJ, LL [31]	150-600 A	(3) 14-1 AWG and (2) 3-2/0 AWG	1.28	PDC5DG20L3	3
	150-600 A	(12) 14-4 AWG	1.31	PDC12DG4L3	3

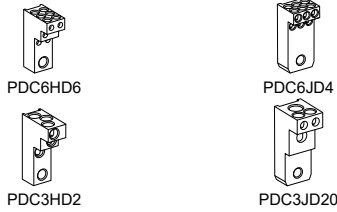

**Table 7.114: Power Distribution Connectors for M-Frame and P-Frame Circuit Breakers [29]**

	Ampere Rating	(Wires Per Terminal) Wire Range	Cat. No.	Qty Per Kit
Use for multiple load connections on one circuit breaker in place of standard distribution block to save space and time. • Use on load end of circuit breaker only • Use in UL508 Industrial Control applications only. • Use in UL1995/CSA C22.2 No. 236 heating and cooling equipment. • For Cu wire only.	250-1200 A	(6) 12-2/0 AWG Cu	PDC6P20	3
		(6) 12-2/0 AWG Cu	PDC6P204	4
	250-1200 A	(12) 10-4 AWG Cu	PDC12P44	4

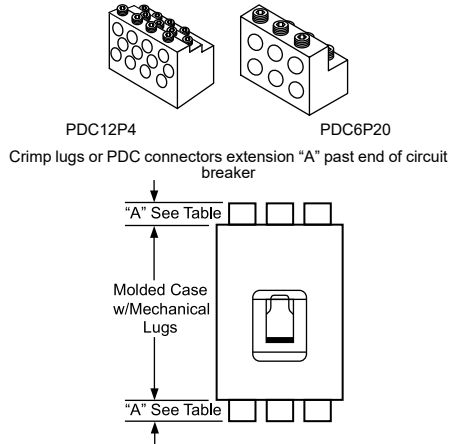

[29] Not for use with I-Line™ circuit breakers.

[30] Special Purpose—Not for General Use. Use on ON end of the circuit breaker only when ON end is used as Load end. Use on OFF end of the circuit breaker only when OFF end is used as Load end.

[31] Kit includes long terminal shield and cover, which adds 1.65 inches to standard lug with short terminal shield.

Terminal Accessories

Table 7.115: Terminal Nuts for Bus Bar Connection of B-, H- and J-Frame Circuit Breakers

Description	Frame	Tap	Cat. No.	Qty Per Kit
B-Frame Terminal Nut Insert-Metric	BD/BG/BJ (2P)	M6	LV426962	2
B-Frame Terminal Nut Insert-Metric	BD/BG/BJ (3P)	M6	LV426963	3
H-Frame Terminal Nut Insert-English	HD/HG/HJ/HL	1/4-20	S37425	2
H-Frame Terminal Nut Insert-English	HD/HG/HJ/HL	1/4-20	S37444	3
H-Frame Terminal Nut Insert-Metric	HD/HG/HJ/HL	M6	S37426	2
J-Frame Terminal Nut Insert-English	JD/JG/JJ/JL	1/4-20	S37427	2
J-Frame Terminal Nut Insert-English	JD/JG/JJ/JL	1/4-20	S37445	3
J-Frame Terminal Nut Insert-Metric	JD/JG/JJ/JL	M8	S37428	2
Control Wire Terminal for H-Frame Terminal Nut	HD/HG/HJ/HL		S37429	2
Control Wire Terminal for J-Frame Terminal Nut	JD/JG/JJ/JL		S37430	2



H-Frame Lug with Terminal Nut Insert

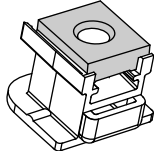

Terminal Nut Insert

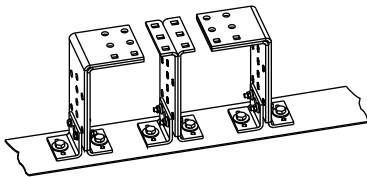

RLTB Terminal Pad Kit

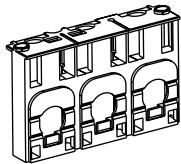

H-Frame Short Lug Shield

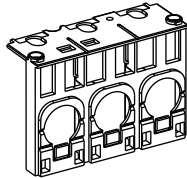

J-Frame Short Lug Shield

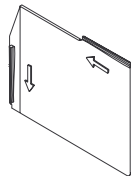
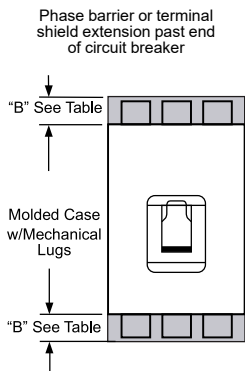

R-Frame Phase Barrier

Table 7.116: Bus Bar Connections Hardware for L-, M-, and P-Frame Circuit Breakers

Frame	Description	Term. No.	Poles	Cat. No.
L-Frame	Set of 4 terminal screws and washers for one side	F	4	S36967
M- and P-Frame	Bus Connector Kit for one pole, one end		1	S33928

Table 7.117: Terminal Pad Kits for R-Frame Circuit Breakers

R-Frame Circuit Breaker	Terminal Pad Kit		Field-Installable Kits	
	Usage	Lugs per Phase	3P Kit (One End Only) Cat. No.	4P Kit (One End Only) Cat. No.
3000 A, 100% Rated	Required for cable or bus	9	RL3TB	RL3TB4
3000 A, Standard (80% Rated)	Required for cable or bus			
2500 A, 100% Rated	Required for cable or bus	8	RLTB	RLTB4
2500 A, Standard (80% Rated)	Required for cable, optional for bus			
All Other R-Frame Circuit Breakers	Required for cable, optional for bus			

For cable connection to RLTB, use AL2500RK lug. See page 7-60.

Table 7.118: Terminal Shields and Phase Barriers

Used With	Description	Dimension B (in.)		Cat. No.	Qty Per Kit		
		Frame	Max. Wire Size				
H- and J-Frame Mechanical Lugs	Short Lug Shield <sup>[32]</sup>	H-Frame 60 A	3 AWG	0.50	S37446	1	
		H-Frame 150 A	3/0 AWG	0.50	S37447	1	
		J-Frame	350 kcmil	0.24	S37448	1	
		Compatible with:					
B-, H- and J-Frame Power Distribution Connectors and Compression Lugs	B-Frame Long Lug Shield	PDC3BD2	LV426988	LV426986	1.9	LV426911 (2P) LV426912 (3P) LV426913 (4P)	1
		PDC6BD6	LV426989	LV426987			
		PDC3HD2	YA150HD	CY-A060HD CY-A150HD			
	H-Frame Long Lug Shield	PDC6JD4	YA150JD	CYA150JD	1.68	S37450	1
		PDC3JD2	[33]	CYA250J3			
	L-Frame	3P Short Terminal Shield				LTSS3P	1
3P Medium Terminal Shield					LTSM3P	1	
3P Long Terminal Shield					LTSL3P	1	
4P Medium Terminal Shield					LTSM4P	1	
4P Long Terminal Shield					LTSL4P	1	
M-, P-Frame	Phase Barriers				S33646	3	
R-Frame					S33998		

Table 7.119: Miscellaneous H-, J-, and L-Frame Circuit Breaker Accessories

Accessory	Description	Field-Installable Cat. No.
Spare Parts	Bag of screws for accessory cover, L-frame	S432552
	1 spare toggle extension, L-frame	32595
	Set of 10 identification labels	LV429226

[32] Short lug shields provide IP20 protection for mechanical lugs and are compatible with control wire terminals.

[33] J-frame terminal shield is not compatible with the YA250J35 compression terminal.

**Mountings**

**Table 7.120: Plug-In and Drawout Mountings for H- and J-Frame Circuit Breakers (3P or 2P in a 3P module)**



H- and J-Frame Plug-In Mounting



H- and J-Frame Drawout Mounting

Description		Factory Installed Cat. No.	Field-Installable Cat. No.	
Complete Factory-Assembled Circuit Breakers	Plug-in base shipped with circuit breaker	N		
	Drawout cradle shipped with circuit breaker	D		
Special Order Options for Plug-In and Drawout Circuit Breakers	Plug-In Base	Circuit breaker Only	HJ00	
		Plug-in base kit	S29278	
	Drawout Cradle	Circuit breaker only	HJ00	
		Plug-in base kit		S29278
		Cradle side plates (fixed part of chassis)		S29282
		Circuit breaker side plates (moving part of chassis)		S29283
Accessories for Plug-In and Drawout	H-Frame Shutter Kit (set of two)		S37442	
	J-Frame Shutter Kit (set of two)		S37443	
	Secondary Disconnect Blocks	Fixed part 9-wire connector (mounted on base)		S29273
		Moving part 9-wire connector (mounted on circuit breaker)		S29274
		Support for 2-moving connectors		S29275
	Extended escutcheon with extended toggle handle		S29284	
	Two position indicating switches (connected/disconnected)		S29287	
	H-Frame Short Terminal Cover (3P)		S37436	
J-Frame Short Terminal Cover (3P)		S37440		



L-Frame Plug-In Mounting



L-Frame Drawout Mounting

**Table 7.121: Plug-In and Drawout Mountings for L-Frame Circuit Breakers**

Description	Poles	Plug-in Mounting		Drawout Mounting		
		Factory-Installed Cat. No.	Field-Installed Cat. No.	Factory-Installed Cat. No.	Field-Installable Cat. No.	
Kit (stationary and moving parts)	3	N		D		
	4	N		D		
Stationary Part	Plug-in base	3	S32514		S32514	
	Fixed part of chassis	4	S32515		S32532	
Moving Part	Circuit breaker only		HJ00		HJ00	
	Moving part of chassis				S32533	
	Short terminal covers	3		2x S32562		2x S32562
		4		2x S32563		2x S32563

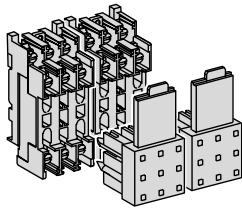

L-Frame Disconnecting Blocks

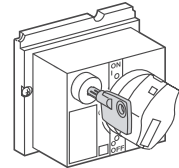

L-Frame Locking Device

**Table 7.122: Plug-In and Drawout Accessories for L-Frame Circuit Breakers**

Description		Field-Installable Cat. No.
Secondary Disconnecting Blocks	Fixed Part	9-wire connector S29273
	Moving Part	9-wire connector S32523
		Support for 3 moving connectors
Shutters	Fixed + Moving	9-wire manual auxiliary connector S29272
Chassis Accessories	Two shutters for plug-in base 32521	
	Extended escutcheon for toggle S32534	
	Locking device (key lock is not included) S29286	
Two position indicating switches (connected/disconnected)		29287

**Table 7.123: Termination Options**

Termination Letter	Termination No.
N = Plug-in	LGL36400U31X
D = Drawout	For factory-installed termination, place termination letter in the third block of the circuit breaker catalog number.

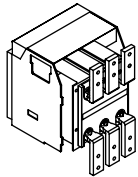

P-Frame Drawout Cradle Connections

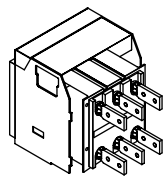

**Table 7.124: Drawout Cradle and Accessories for P-Frame Circuit Breakers**

Description		Cat. No.
Drawout Cradle		Product Selector
Cradle Connectors	Front Connected Flat (FCF)	SFCF12 [34]
	Rear Connected T Horizontal/Vertical (RCTH/RCTV)	SRCTV12 [34]
Cradle Accessories	Modbus™ cradle communication module	S33852
	Safety shutters	S48933
	Secondary disconnects terminal shield	S33763
	Cradle position switch 1a/1b Form C—Connected/test/disconnected	S33170
	Low level cradle position switch 1a/1b Form C—Connected/test/disconnected	S33171
	Cell keying kit	S33767
	Disconnected position key locking—provision for Kirk or Federal Pioneer Lock	S33772
	Door interlock kit	S33786
	Racking interior kit	S33788
	Door escutcheon (for replacement only, included with circuit breaker)	S33857
	Transparent cover	S33859
	Push-in terminal kit (3 wires)	S33098
	Push-in terminal kit (6 wires)	S33099
	Finger cluster	S33166
	Cluster grease (12 oz. tube)	S48899

[34] Needs 2 kits per cradle.

PowerPact H-, J-, and L-Frame Micrologic Trip Units



**Micrologic Trip Units [1]**

**Micrologic Standard 3.2/3.3 Trip Units**

PowerPact™ H-, J-, and L-frame molded case circuit breakers may be specified with any of the following Micrologic Electronic Trip Units.

- True RMS sensing
- LI, LSI trip configurations
- Field-interchangeable trip units
- LED long-time pickup and trip indication
- Test kits available
- Thermal imaging

**Micrologic Ammeter 5.2A/5.3A/6.2A/6.3A Trip Units**

Includes all features listed for Micrologic standard trip unit, as well as:

- Advanced user interface
- Neutral protection
- Incremental fine tuning of settings
- Up to 12 alarms
- Digital ammeter—phase and neutral (4-pole only)
- Phase loading bar graph
- Maintenance indicators including contact wear, number of operations, operating hours, and load profiles
- Cause of trip information for troubleshooting assistance
- LCD Display
- Zone-selective interlocking (ZSI) (short-time & ground-fault)
- Optional Modbus™ communications—PowerLogic™ compatible

**Micrologic Energy 5.2E/5.3E/6.2E/6.3E Trip Units**

Includes all features listed for Micrologic ammeter trip unit, as well as:

- Ground-fault trip with programmable ground fault alarm (available on 6.2E/6.3E only)
- Power and energy measurement
- Power quality measurements
- Current demand and power demand measurements

**Table 7.125: Micrologic Trip Unit Settings for H- and J-Frame**

Model	Trip Function	Trip Unit	Ampere Setting
Standard	LI	3.2	15-20-25-30-35-40-45-50-60
			35-40-45-50-60-70-80-90-100
	LSI	3.2S	50-60-70-80-90-100-110-125-150
			70-80-100-125-150-175-200-225-250
Ammeter	LSI	5.2A	15-60
			35-100
	LSIG	6.2A	50-150
			70-250
Energy	LSI	5.2E	15-60
			35-100
	LSIG	6.2E	50-150
			70-250

**Table 7.126: Micrologic Trip Unit Settings for L-Frame**

Model	Trip Function	Trip Unit	Ampere Setting
Standard	LI	3.3	70-80-100-125-150-175-200-225-250
			125-150-175-200-225-250-300-350-400
Ammeter	LSI	5.3A	200-225-250-300-350-400-450-500-600
			70-80-100-125-150-175-200-225-250
Energy	LSI	5.3E	125-400
			200-600
LSIG	6.3A	6.3E	125-400
			200-600

[1] See Supplemental Digest Section 3 for circuit breakers with field-interchangeable trip units.

**Table 7.127: Micrologic Trip Units [2] for PowerPact H-, J-, and L-Frame Circuit Breakers**

x – Standard Feature    o – Available Option

Features	Standard		Ammeter		Energy	
	3.2/3/3	3.2S/3.3S	5.2A/5.3A	6.2A/6.3A	5.2E/5.3E	6.2E/6.3E
LI	x					
LSI [3]		x	x		x	
LSIG / Ground-Fault Trip[4]				x		x
Ground-Fault Alarm/Trip[4]				x		x
Current Setting Directly in Amperes	x	x	x	x	x	x
True RMS Sensing	x	x	x	x	x	x
UL Listed	x	x	x	x	x	x
Thermal Imaging	x	x	x	x	x	x
LED for Long-time Pickup	x	x	x	x	x	x
LED for Trip Indication	x	x	x	x	x	x
LED for Green "Ready"	x	x	x	x	x	x
Up to 12 Alarms Used Together			x	x	x	x
Digital Ammeter			x	x	x	x
Zone-selective Interlocking [5]			x	x	x	x
Communications	o	o	o	o	o	o
LCD Display			x	x	x	x
Front Display Module FDM121			o	o	o	o
Advanced User Interface			x	x	x	x
Neutral Protection[4]			x	x	x	x
Contact Wear Indication [6]			x	x	x	x
Incremental Fine Tuning of Settings			x	x	x	x
Load Profile [6],[7]			x	x	x	x
Power Measurement					x	x
Power Quality Measurements					x	x

[2] DC not available with electronic trip units.  
 [3] The LSI with 3.2S/3.3S trip units have fixed short time and long time delays.  
 [4] Requires neutral current transformer on the three-phase four-wire loads.  
 [5] ZSI for H/J frames in only OUT. for L-frame ZSI is In and OUT.  
 [6] Indication available using the communication system only.  
 [7] % of hours in 4 current ranges: 0–49%, 50–79%, 80–89%, and >90% In.

## PowerPact P- and R-Frame Micrologic Trip Units

PowerPact P- and R-Frame Micrologic Trip Units



Standard Trip Unit

Ammeter Trip Unit

Power Trip Unit

Harmonic Trip Unit

Adjustable Rating Plug

### Micrologic (Standard) 3.0 and 5.0 Trip Units

PowerPact™ P- and R-frame molded case circuit breakers may be specified with any of the following Micrologic Electronic Trip Units.

- True RMS sensing
- LI, LSI trip configurations
- Field-interchangeable long-time rating plugs
- LED long-time pickup indication
- Test kits available
- Thermal imaging

### Micrologic (Ammeter) 3.0A, 5.0A and 6.0A Trip Units

Includes all features listed for Micrologic standard trip unit, as well as:

- LSIG trip configurations
- Digital ammeter—phase and neutral (4-pole only)
- Phase loading bar graph
- LED trip indication
- Zone-selective interlocking (ZSI) (short-time & ground-fault)
- Optional Modbus™ communications—PowerLogic™ compatible

### Micrologic (Power) 5.0P and 6.0P Trip Units

Power measurement and advanced protection features includes all features listed for Micrologic ammeter trip unit, as well as:

- LSI trip configuration with programmable ground fault alarm
- LSIG (Ground-fault trip) with programmable ground fault alarm
- Incremental “fine tuning” of L, S, I, and G pickup and delay settings
- LCD dot matrix display and LED trip indication
- Advanced user interface
- Advanced protection IDMTL—selectable long-time delay bands
- Neutral protection
- Power measurement
- Contact wear indication
- Modbus communications—PowerLogic compatible
- Local and remote settings

### Micrologic (Harmonic) 5.0H and 6.0H Trip Units

Power quality measurement and advanced protection features. Includes all features listed for the Micrologic power trip unit, as well as:

- Enhanced power measurements functions
- Power quality measurements

### Adjustable Rating Plugs for PowerPact™ P-Frame and R-Frame and Masterpact™ NT and NW Circuit Breakers—Selection

To provide maximum design flexibility, system protection, and field upgradeability, each Micrologic™ trip unit is equipped with an interchangeable long-time rating plug. Each trip unit requires an adjustable rating plug to determine the long-time pickup range of the circuit breaker. These plugs are factory installed on new trip units, or can be ordered separately for field-installable upgrades.

Adjustable rating plugs are offered in eight different ranges of long-time pickup adjustments. The following chart show the ranges of adjustments. Each adjustment times the sensor rating ( $I_r \times I_n$ ) of the circuit breaker sets the long-time pickup value of the circuit breaker.

**Table 7.128: Micrologic Trip Unit and Options**

Model	Protection	Additional Features	Field-Installable Cat. No./[8]
2.0 (IEC only)	LSO	None	S132R
3.0 (UL/ANSI only)	LI		S131A
5.0	LSI		S133A
2.0A (IEC only)	LSO	Ammeter	S142R [9]
3.0A (UL/ANSI only)	LI		S141A [9]
5.0A	LSI		S143A [9]
6.0A	LSIG		S144A [9]
5.0P	LSI	Metering, Adv. Protection	S163A [9][10]
6.0P	LSIG		S164A [9][10]
5.0H	LSI	Metering, Adv. Protection & Harmonic Analysis	S173A [9][10]
6.0H	LSIG		S174A [9][10]

**Table 7.129: Micrologic Trip Units**

**x – Standard Feature    o – Available Option**

Features	Standard		Ammeter			Power		Harmonic	
	3.0	5.0	3.0A	5.0A	6.0A	5.0P	6.0P	5.0H	6.0H
LI	x		x						
LSI (Instantaneous can be turned off)		x		x	x	x	x	x	x
LSIG / Ground-Fault Trip [11]					x		x		x
Ground-Fault Alarm (No Trip) [11][12]						x		x	
Ground-Fault Alarm and Trip [11][12]							x		x
Adjustable Rating Plugs	x	x	x	x	x	x	x	x	x
True RMS Sensing	x	x	x	x	x	x	x	x	x
UL Listed	x	x	x	x	x	x	x	x	x
Thermal Imaging	x	x	x	x	x	x	x	x	x
Phase Loading Bar Graph			x	x	x	x	x	x	x
LED for Long-time Pickup	x	x	x	x	x	x	x	x	x
LED for Trip Indication			x	x	x	x	x	x	x
Digital Ammeter			x	x	x	x	x	x	x
Zone-selective Interlocking			x	x	x	x	x	x	x
Communications			o	o	o	x	x	x	x
LCD Dot Matrix Display						x	x	x	x
Advanced User Interface						x	x	x	x
Protective Relay Functions						x	x	x	x
Neutral Protection						x	x	x	x
Contact Wear Indication						x	x	x	x
Incremental Fine Tuning of Settings						x	x	x	x
Selectable Long-time Delay Bands						x	x	x	x
Power Measurement						x	x	x	x
Power Quality Measurements								x	x
Waveform Capture								x	x

**Table 7.130: Long-Time Pickup Settings**

Rating Plug	Long-time Pickup Settings								
A	.40	.45	.50	.60	.63	.70	.80	.90	1.0
B	.40	.44	.50	.56	.63	.75	.88	.95	1.0
C	.42	.50	.53	.58	.67	.75	.83	.95	1.0
D	.40	.48	.64	.70	.80	.90	.93	.95	1.0
E	.60	.70	.75	.80	.85	.90	.93	.95	1.0
F	.84	.86	.88	.90	.92	.94	.96	.98	1.0
G	.66	.68	.70	.72	.74	.76	.78	.80	.82
H	.48	.50	.52	.54	.56	.58	.60	.62	.64

**Table 7.131: Special Options**

Description	Factory-Installed Suffix	Field-Installable Cat. No.
Ship circuit breaker in closed position	YK	N/A
CT Characterization (Calibrated trip system)	Q	N/A
Alternate Maintenance Setting (AMS) kit (use with 5.0/6.0 A, P or H and 5.3/6.3 A or E Micrologic trip units)	—	84957
Energy Reduction Maintenance Setting (ERMS) kit (use with 5.0/6.0 P or H Micrologic trip units)	—	84956

[8] The standard rating plug supplied with a trip unit will be the "A" rating plug. To specify an alternative adjustable rating plug, please add the letter designation to the end of the catalog number. Please refer to page 7-68 for a complete listing of adjustable settings available with each plug. (Example: S143B would specify a "B" rating plug instead of the standard "A" plug.) Use suffix "N" if no rating plug is required, deduct.

[9] When replacing a standard trip unit with Type A (Ammeter), P (Power metering) or H (Harmonic analysis) trip unit, order the 12-pin connector kit S33101 for the Masterpact NW and NT and the PowerPact P-frame drawout circuit breakers or kit S33100 for PowerPact P-frame and R-frame unit-mount and I-Line circuit breakers. See page 7-68.

[10] Requires Circuit Breaker Communications Module.

[11] Requires neutral current transformer in 3Ø4W systems.

[12] Alarm history is available through the trip unit display and communications. Local indication of an alarm requires an M2C or M6C Programmable Contact Module.



Full Function Test Kit

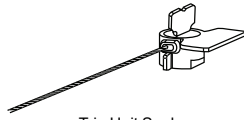

Trip Unit Seal



Sensor Plug

Table 7.132: Rating Plugs

Rating Plug [13]	Factory Installed Cat. Suffix	Field-Installable Cat. No.
A	A (standard)	S48818
B	B	S48819
C	C	S48820
D	D	S48836
E	E	S48837
F	F	S48838
G	G	S48839
H	H	S48840

Table 7.133: Neutral Current Transformers

For Use with Circuit Breaker	Cat. No.	Sensor
H-Frame	S429521	60–100
	S430562	150
J-Frame	S430563	250
L-Frame	S432575	400–600
P-Frame	S33575 [14]	250
	S33576 [14]	400–1600
R-Frame	S48916 [14]	250
	S34036 [14]	400–1600
	S48896 [14]	2000
	S48182 [14]	3000
All	NCTWIRING	All

Trip Unit Accessories

Adjustable rating plug "A" is installed as standard on all Micrologic trip unit orders. However, an alternative selection may be specified from the "Assembled" table below, and factory installed with your trip unit order at no additional charge. To order, please attach the appropriate catalog suffix to the end of the trip unit Cat. No. (after specifying trip unit options). Adjustable rating plugs may also be purchased as field-installable components from the table below.

Table 7.134: Trip Unit Accessories

Device	Frame	Cat. No.
Pocket Tester	H/J/L	S434206
UTA Tester		STRV00910
Spare UTA Tester		STRV00911
Bluetooth/Modbus for UTA Tester		SVW3A8114
Spare Power Supply for UTA Tester 110–120 Vac		TRV00915
Micrologic Cord for UTA Tester		TRV00917
Micrologic 5/6 Cover, Transparent	H/J	S429478
Micrologic 2/3 Cover, Transparent		S429481
Micrologic 5/6 Cover, Transparent	L	S432459
Micrologic 2/3 Cover, Transparent		S432461
LCD Display for Micrologic 5	H/J/L	S429483
LCD Display for Micrologic 6		S429484
Hand-held Test Kit	P/R	S33594
Primary Injection Test Adaptor		S33937
Full-function Adapter Kit		S48981
Full-function Test Kit		S33595
Seven-pin Test Cable (for connection between test kit and trip unit)[15]		S48907
Two-pin Test Cable (for connection between test kit and trip unit)[16]		S48908
230 Vac Filtered Power Cord[17]		S48856
120 Vac Filtered Power Cord[17]	P/R	S48855
Trip Unit Battery for Trip Indicator Lights		S33593
Power supply with:	H/J/L/P/R	
24–30 Vdc input		685823
48/60 Vdc input		685824
125 Vdc input		685825
110–130 Vac input		685826
200–240 Vac input		685827
380–415 Vac input	685829	
Micrologic A Trip Unit Cover, clear	P/R	S33592
Micrologic P/H Trip Unit Cover, opaque gray		S47067
Trip Unit Seal (6 pieces) for compliance with NEC 240.6(c)	H/J/L/P/R	MICROTUSEAL
12-pin Trip Unit Connector for NT/NW Masterpact Circuit Breakers	P/R	S33101
12-pin Trip Unit Connector for P- and R-Frame Circuit Breakers		S33100
Battery Back-up (12 Hours)		685831

Table 7.135: Sensor Plugs for P- and R-Frame Circuit Breakers [18][19]

Circuit Breaker	Sensor Plug Range	Sensor Plug Catalog No.	Circuit Breaker Frames Accepting Sensor Plug									
			250 A	400 As	600 As	630 A [20]	800 A	1000 A	1200 A	1250 A [20]	1600 A	
P-Frame Circuit Breaker	250 A	S47052	X									
	400 A	S47053		X	X		X					
	600 A	S48823			X		X	X	X			
	800 A	S33092					X	X	X			
	1000 A	S33093						X	X			
	1200 A	S48824							X			
IEC	630 A	S33091				X	X	X		X	X	
	800 A	S33092					X	X		X	X	
	1000 A	S33093						X		X	X	
	1250 A	S33094								X	X	
	1600 A	S33095										X
R-Frame Circuit Breaker	600 A	S48823	X	X	X	X						
	800 A	S33092		X	X	X	X					
	1000 A	S33093			X	X	X	X				
	1200 A	S48824				X	X	X	X			
	1600 A	S33095					X	X	X	X		
	2000 A	S33982						X	X	X		
	2500 A	S33983							X	X	X	
	3000 A	S48825								X		
	1600 A	S33095					X	X	X	X	X	
	2000 A	S33982						X	X	X	X	
	2500 A	S33983							X	X	X	
	3200 A	S33984										X

[13] Long-time pickup amperes (Ir) = Sensor Rating (In) X Setting of rating plug. "Fine adjustment tuning" is included on Micrologic Power and Harmonic trip units, allowing for incremental settings of 1 A between the plug setting and .40 X Sensor Rating.

[14] Includes NCTWIRING kit.

[15] Used for testing Micrologic trip units. Included in the price of the Hand-held/Full-function Test Kits. Kit for replacement only.

[16] Used for testing STR trip units. Included in the price of the Hand-held/Full-function Test Kits. Kit for replacement only.

[17] Included with the Full-function Test Kit. Kit for replacement only.

[18] For use only with circuit breakers with date codes later than 07011.

[19] See rating plug for long-time pickup range page 7-64.

[20] IEC Only.

**Trip Unit Accessories**

**Table 7.136: Communication Modules, Display Screens, and Wiring Accessories**



Modbus Interface Module (IFM)      Ethernet Interface (IFE)



Front Display Module (FDM121)      Ethernet LCD Color Touch Display (FDM128)

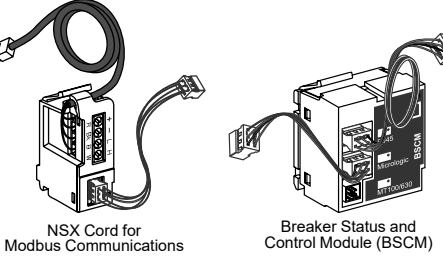

NSX Cord for Modbus Communications      Breaker Status and Control Module (BSCM)

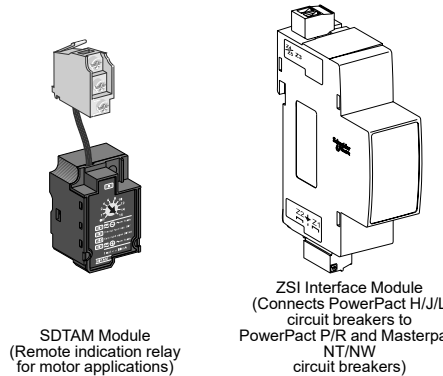

SDTAM Module (Remote indication relay for motor applications)      ZSI Interface Module (Connects PowerPact H/J/L circuit breakers to PowerPact P/R and Masterpact NT/NW circuit breakers)

Description	Field-Installable Kit Cat. No.	
IFM Modbus-SL Interface for LV Circuit Breaker	LV434000	
Stacking Accessory (10 Stacking Accessories for IFM)	TRV00217	
IFE Interface (Ethernet Module)	LV434001	
IFE Interface + Gateway (Ethernet and Modbus Gateway)	LV434002	
I/O Module (Input/Output Programmable Module)	LV434063	
Circuit Breaker ULP Cord—BCM to COMS	L = 0.35 m (1.15 ft)	LV434195
	L = 1.3 m (4.27 ft)	LV434196
	L = 3 m (9.24 ft)	LV434197
ULP Cable, 10 Cables (Male to Male RJ45)	L = 0.3 m (0.98 ft)	TRV00803
	L = 0.6 m (1.97 ft)	TRV00806
ULP Cable, 5 Cables (Male to Male RJ45)	L = 1 m (3.28 ft)	TRV00810
	L = 2 m (6.56 ft)	TRV00820
	L = 3 m (9.84 ft)	TRV00830
ULP Cable, 1 Cable (Male to Male RJ45)	L = 5 m (16.40 ft)	TRV00850
RJ45 Female/Female Connector, 10 Connectors	TRV00870	
ULP Line Terminator, 10 Terminators	TRV00880	
Insulated ULP Module and Circuit Breaker Cord (for System Voltage Greater than 480 Vac) (Cord with Female Socket)	L = 1 m (3.28 ft)	S434204
	L = 3 m (9.84 ft)	S434303
Two-Wire RS 485 Isolated Repeater Module	STRV00211	
Modbus Line Terminator for Screw Terminal, 2 Terminators	VW3A8306DRC	
Modbus Line Terminator for RJ45 Terminal, 2 Terminators	VW3A8306RC	
FDM121 (1 Circuit Breaker to 1 Front Display)	STRV00121	
Surface-Mounting Accessory for FDM121	TRV00128	
FDM128 (8 Circuit Breakers to 1 Front Display)	LV434128	

**Table 7.137: Trip Unit Field-Installable Accessories, Wire Harness [21] and ULP Cords for H-, J-, and L-Frame Circuit Breakers [22]**

Description	Factory-Installed Cat. No. Suffix	Field-Installable Kit Cat. No.
<b>External Accessories</b>		
Isolated Modbus Repeater Module	—	STRV00211
ZSI Interface Module	—	S434212
<b>Internal Accessories</b>		
NSX Cord [23] (for Modbus Communication)	L = 1.3 m (4.27 ft)	EA
	L = 3 m (9.84 ft)	EB
BSCM (Breaker Status and Control Module) with NSX Cord [23]	L = 1.3 m (4.27 ft)	EG [24]
	L = 3 m (9.84 ft)	EH [24]
Replacement BSCM	—	S434205
BSCM with NSX Cord for V > 480 Vac [23]	L = 1.3 m (4.27 ft)	EK [24]
	L = 3 m (9.84 ft)	EL [24]
24 Vdc Terminal Block	EN	S434210
SDTAM 24/415 Vac/dc Module [25]	V	S429424
SDX Module 24/415 Vac/dc [26]	V	S429532
ZSI Wire Harness, H/J Frame	YH3	S434300
ZSI Wire Harness, L-Frame	YH3	S434301
ENCT Wire Harness	YH2	S434302
OF Wire Harness	YH1	S434500
SD/SDE Wire Harness	YH1	S434501
SDx/SDTAM Wire Harness	YH1	S434502
MN Wire Harness	YH1	S434503
MX Wire Harness	YH1	S434504
24 Vdc Terminal Block Wire Harness [27]	YH1	S434505
Motor Operator Wire Harness	YH1	S434506
Communicating Motor Operator Wire Harness	YH1	S434507
NSX Wire Harness [27]	YH1	S434508
ENCT and ZSI Wire Harness	YH4	—

**Table 7.138: Trip Unit Field-Installable Accessories for P- and R-Frame Circuit Breakers**

Description	Factory-Installed Cat. No. Suffix	Field-Installable Kit Cat. No.						
		P-Frame					R-Frame	
		Unit Mount	I-Line	Motor Operated	Drawout	With Rotary Handle	Unit Mount	I-Line
Circuit Breaker Communication Module (BCM) (Modbus)	E1	S64205	S64205	S64207	S64206	S64205	S64205	S64205
Two Programmable Contacts Module (M2C)	V	S64273	S64273	S64273	S64273	S64273	S64273	S64273
Six Programmable Contacts Module (M6C)	W	S64204	S64204	S64204	S64202	S64204	S64201	S64201
External Voltage Sensing (EVS)	YV	S64203	S64203	S64210	S64209	S64210	S64208	S64208

[21] Wire harness is required for I-Line applications, optional for unit-mount applications  
 YH1 = all installed accessories but ZSI and ENCT  
 YH2 = ENCT and all installed accessories  
 YH3 = ZSI and all installed accessories  
 YH4 = ZSI, ENCT and all installed accessories  
 [22] For proper selection, see catalog 0611CT1001.  
 [23] Installation requires IFM (STRV00210) for Modbus communication and/or FDM (STRV00121) for external display.  
 [24] If using with motor operator requires communicating motor operator (suffix NC).  
 [25] Remote indication relay for motor applications  
 [26] Remote indication relay  
 [27] I-Line wire harness is included for communication network accessories.  
 Optional wire harness for unit mount requires YH1 suffix.



**Full-Featured Performance**

The Masterpact universal power circuit breaker offers a family of circuit protection products meeting the most common world standards, ANSI, UL and IEC. The basic design platform for each is common. The final result is UL, ANSI and IEC circuit breakers with the same basic external dimensions, features and accessories.

- Complete product offering up to 200 k AIR without fuses
- Circuit breakers tested to show arc flash hazard risk category as referenced by NFPA70E
- 800 A to 6000 A frames, fixed and draw-out
- Rated for AC voltage systems through 600 V (635 V ANSI)
- Short-time withstand ratings up to 100 kA
- Cradle position indicator: connected, test and disconnected
- Simple, visual contact wear indicators
- Full complement of field-installable accessories common to all standards
- Four interchangeable Micrologic trip units to choose from
- Available PowerLogic™ based power metering and monitoring capabilities
- Available protective relay functions as defined by ANSI C37.2 and C37.90

The following charts show the Masterpact NW and NT ratings for ANSI and UL 489. See Pricing Guide 0613PL0001 and Catalog 0613CT0001.

**Table 7.139: Masterpact NW Circuit Breaker Ratings**

Standard Frame Rating Interrupting Code	ANSI C37 Certified/UL 1066 Listed																		UL 489 Listed										
	800–1600 A						2000 A						3200/4000 A [1]						4000/5000 A			800/1200/1600/2000 A			2500/3000 A		4000/5000/6000 A		
	N1	H1	H2	H3	L1 [2]	L1F [2]	H-1	H2	H3	L1 [2]	L1F [2]	H1	H2	H3	L1 [2]	L1F [2]	H2	H3	L1 [2]	N	H	L [2]	LF [2]	H	L [2]	H	L [2]		
Interrupting Current (kA RMS) 50/60 Hz	240 Vac	42	65	85	100	200	200	65	85	100	200	200	65	85	100	200	85	100	200	65	100	200	200	100	200	100	200		
	480 Vac	42	65	85	100	200	200	65	85	100	200	200	65	85	100	200	85	100	200	65	100	150	150	100	150	100	150		
	600 Vac	42	65	85	85	130	130	65	85	85	130	130	65	85	85	130	85	85	130	50	85	100	100	85	100	85	100		
Short-time Withstand Current (kA RMS)		42	65	85	85	30	22	65	85	85	30	22	65	85	85	100	85	85	100	42 [3]	65 [3]	30 [3] [4]	22	65	65	85	100		
Built-in Instantaneous Override (kA RMS ±10%)		35 [5]	35 [5]	35 [5]	85	35 [5]	24	—	—	85	35	24	—	—	85	117	—	—	117	40	40	35 [3] [4]	24	65	65	75	75		
Close and latch rating (kA RMS)		42	65	40	40	25	22	65	40	40	25	22	65	40	40	40	85	75	40	40	40	25 [6]	22	40	40	40	40		
Tested to show arc flash hazard risk category as referenced by NFPA70E		—	—	—	—	—	Yes	—	—	—	—	Yes	—	—	—	—	—	—	—	—	—	—	Yes	—	—	—	—		
Breaking time	25–30 ms with no intentional delay (9 ms for L1, L1F, L and LF)																												
Closing time	70 ms																												
Sensor Rating	100–250 A 400–800 A 800–1600 A						1000–2000 A						1600–3200 A						2000–4000 A 2500–5000 A			100–250 A 400–800 A 600–1200 A 800–1600 A 1000–2000 A			1200–2500 A 1600–3000 A		2000–4000 A 2500–5000 A 3000–6000 A		
Endurance Rating (C/O Cycles) With No Maintenance	Mechanical	12,500						10,000						10,000			5k			5,000			12,500 [7]			10,000		5,000	
	Electrical	2800						1,000						1,000			1k			1,000			2800 [7]			1,000		1,000	

[1] 4000 A standard width circuit breaker is not available in L1 interrupting rating code or drawout construction (fixed mounting only).  
 [2] Drawout mounted only.  
 [3] 24 kA RMS for 800 A circuit breaker frame with 100 A or 250 A sensor.  
 [4] 65 kA RMS for 2000 A.  
 [5] None except 24 kA RMS for 800 A circuit breaker frame with 100 A or 250 A sensor.  
 [6] 40 kA RMS for 2000 A.  
 [7] The endurance rating for 2000 A, N/H/L/LF is 10,000 for mechanical and 1000 for electrical.

Table 7.140: Masterpact NT Circuit Breaker Ratings

Standard Frame Rating Interrupting Code	ANSI C37 Certified/ UL 1066 Listed	UL 489 Listed														
		800 A						1200 A				1600 A [8]				
		N1	N	H	L1	L	LF [9]	N	H	L1	L	LF [9]	N	H	L1	L
Interrupting Current (kA RMS) 50/60 Hz	240 Vac	42	50	65	100	200	200	50	65	100	200	200	50	65	100	200
	480 Vac	42	50	50	65	100	100	50	50	65	100	100	50	50	65	100
	600 Vac	—	35	50	—	—	—	35	50	—	—	—	35	50	N/A	N/A
Short-time Withstand Current (kA RMS)	42	35	35	10	10	10	10	35	35	10	10	10	35	35	10	10
Built-in Instantaneous Override (kA RMS ±10%)	—	40	40	10	10	10	10	40	40	10	10	10	40	40	10	10
Close and latch rating (kA RMS)	40	25	25	10	10	10	10	25	25	10	10	10	25	25	10	10
Tested to show the arc flash hazard risk category as referenced by NFPA70E	—	—	—	—	—	—	Yes	—	—	—	—	Yes	—	—	—	—
Breaking time	25–30 ms with no intentional delay	25–30 ms with no intentional delay (9 ms for L and LF)														
Closing time	< 50 ms															
Sensor Rating	100–250 A	100–250 A				600–1200 A				800–1600 A						
	400–800 A	400–800 A				—				—						
Endurance Rating (C/O Cycles) With No Maintenance	Mechanical	12,500				12,500				12,500						
	Electrical	2800				2800				2800						



NWMPRR

Table 7.141: Masterpact NW/NT Circuit Breaker Remote Racking

Description	Cat. No.
Masterpact NW/NT Remote Racking Devices [10]	NWNTMPRRT
Masterpact NW Remote Racking Device [10]	NWMPRRT
Masterpact NT Remote Racking Device [10]	NTMPRRT
Mounting Bracket Kit for NW Remote Racking (contains 10 mounting brackets) [11]	S47100
Mounting Bracket Kit for NT Remote Racking (contains 10 mounting brackets) [11]	S47104
Control Unit for NW Remote Racking [11]	S47101
30 ft Control Cable for NW Remote Racking [11]	S47102
Drive Shaft for NW Remote Racking [11]	S47103
Drive Shaft for NT Remote Racking [11]	S47105

[8] Fixed mounted only.  
 [9] Drawout mounted only.  
 [10] Unit comes with 10 mounting brackets included.  
 [11] For replacement only.

### Vigirex™ Ground-Fault Relay System

The Vigirex ground-fault relays, with associated sensors (current transformers), measure the residual current in an electrical installation to detect levels which may be damaging. When used for protection, they cause an associated circuit breaker or switch to interrupt the supply of power to the protected system. They may also be used for monitoring only, with output to an alarm. The product line includes fixed sensitivities from 30 mA to 1 A and adjustable sensitivities up to 30 A.

The Vigirex relays may be easily mounted on DIN rail or may be panel mounted in a meter cutout. Sensors for conductors range from a little more than an inch diameter toroids, to large rectangular sensors measuring 6 x 18 inches. The compact size of the relay and its sensor make it ideal for protection of OEM equipment as well as branch circuits.

Table 7.142: Vigirex Ground-Fault Relays (UL 1053 Listed)

Model	Delay	Reset	Control Voltage	Sensitivity	Cat. No.
<b>DIN Rail Mounted</b>					
RH10M	Instantaneous	Manual	12–24 Vac/12–48 Vdc	30 mA	56300
				100 mA	56302
				300 mA	56305
				500 mA	56306
				1 A	56307
				30 mA	56320
			110–130 Vac	100 mA	56322
				300 mA	56325
				500 mA	56326
				1 A	56327
				30 mA	56330
				100 mA	56332
220–240 Vac	300 mA	56335			
	500 mA	56336			
	1 A	56337			
	30 mA	56360			
	110–130 Vac	56362			
	220–240 Vac	56363			
RH21M	Instantaneous or 60 msec (2 settings)	Manual	12–24 Vac/12–48 Vdc 110–130 Vac 220–240 Vac	30 mA <sup>[1]</sup> or 300 mA (2 settings)	56370TD 56372TD 56373TD
RH99M	Adjustable (9 settings): 0, 0.06, 0.15, 0.23, 0.31, 0.5, 0.8, 1.0, 4.5 sec	Manual	12–24 Vac/12–48 Vdc	Adjustable, (9 settings): 0.03 <sup>[1]</sup> , 0.1, 0.3, 0.5, 1, 3, 5, 10, 30 A	56390TD
			110–130 Vac		56392TD
			220–240 Vac		56393TD
		Automatic	12–24 Vac/12–48 Vdc		56390TD
			110–130 Vac		56392TD
			220–240 Vac		56393TD
<b>Panel Mounted</b>					
RH10P	Instantaneous	Manual	12–24 Vac/12–48 Vdc	30 mA	56400
				100 mA	56402
				300 mA	56405
				500 mA	56406
				1 Amp	56407
				30 mA	56420
			110–130 Vac	100 mA	56422
				300 mA	56425
				500 mA	56426
				1 Amp	56427
				30 mA	56430
				100 mA	56432
220–240 Vac	300 mA	56435			
	500 mA	56436			
	1 A	56437			
	30 mA	56460			
	110–130 Vac	56462			
	220–240 Vac	56463			
RH21P	Instantaneous or 60 msec (2 settings)	Manual	12–24 Vac/12–48 Vdc 110–130 Vac 220–240 Vac	30 mA <sup>[1]</sup> or 300 mA (2 settings)	56470TD 56472TD 56473TD
RH99P	Adjustable (9 settings): 0, 0.06, 0.15, 0.23, 0.31, 0.5, 0.8, 1.0, 4.5 sec	Manual	12–24 Vac/12–48 Vdc	Adjustable (9 settings): 0.03 <sup>[1]</sup> , 0.1, 0.3, 0.5, 1, 3, 5, 10, 30 A	56490TD
			110–130 Vac		56492TD
			220–240 Vac		56493TD
		Automatic	12–24 Vac/12–48 Vdc		56490TD
			110–130 Vac		56492TD
			220–240 Vac		56493TD



RH99M



RH99P

Table 7.143: Sensors for Vigirex Ground-Fault Relays

Sensors	Type	Maximum Current [2]	Inside Diameter		Cat. No.
			in.	mm	
Closed Toroids, Type A	TA30	65 A	1.18	30	50437
	PA50	85 A	1.97	50	50438
	IA80	160 A	3.15	80	50439
	MA120	250 A	4.72	120	50440
	SA200	400 A	7.87	200	50441
	GA300	630 A	11.81	300	50442
Vigirex Sensor Iron Rings (Optional)	TA30	65 A	0.79	20	56055
	PA50	85 A	1.58	40	56056
	IA80	160 A	2.76	70	56057
	MA120	250 A	4.33	110	56058
Split toroids, Type TOA	TOA80	160 A	3.15	80	50420
	TOA120	250 A	4.73	120	50421
	Rectangular Sensors	280 x 115	1600 A	11.02 x 4.53	280 x 115
470 x 160		3200 A	18.50 x 6.30	470 x 160	56054



PA50



SA200

[1] 30 mA is instantaneous only, except for RH99M and RH99P models. Their suffix TD indicates time delay at 30 mA. For models with no time delay (IEC compliant) consult catalog 0972CT0401.

[2] Use as a guideline for sizing wire through sensor.



GFM250 with Optional GFM25CT

**Micrologic™ Add-on Ground-Fault Module (GFM)**

The Micrologic Ground-Fault Module (GFM) is a UL Listed/CSA Certified circuit breaker accessory which protects equipment from damage caused by ground faults. It is an add-on module which, when connected to a PowerPact H- or J-frame thermal-magnetic circuit breaker only, provides ground-fault sensing and ground-fault relay functions.

HD/JD ground-fault modules feature:

- Adjustable ground-fault pickup levels
- Adjustable ground-fault time delays
- Integral ground fault push-to-test feature
- Ground-fault indicator (mechanical for local, contacts for remote)
- All GFMs are supplied for I-Line™ mounting as standard, easily convertible to unit mount by removing the I-Line bracket
- Fault-powered (through the sensing current transformer) for electronics, shunt trip, and integral test feature. Meets NEC 230.95(C)
- A 12 Vdc shunt trip module (Catalog No. S29382) is required in the circuit breaker. This may be field installed or factory installed when the circuit breaker is ordered with an -SN suffix.
- UL 1053 — Ground-fault Sensing and Relaying Equipment

The GFM system requires the following:

- H-frame (15–150 A) or J-frame (150–250 A) molded case circuit breaker
- Shunt trip is required for the function of the GFM (may be factory-installed or field-installed)
- Bus bar connection (terminal nut inserts) for OFF end of circuit breaker
- Optional neutral current transformer, catalog number GFM25CT (must be ordered for 4-wire applications).NOTE: Ground-fault modules cannot be used for alarming only.

**Table 7.144: Module/Enclosure Selection Chart [3]**

Companion Circuit Breaker Prefix	Cat. No. [4]	I-Line Switchboard	Ground-fault Pickup Adjustment Range
HD, HG, HJ, HL	GFM150HD	LA	20–100 A
JD, JG, JJ, JL	GFM250JD	LA	40–200 A
Accessories			
H & J	GFM25CT	Optional Neutral Current Transformer (required for 4-wire loads)	

**Earth Leakage Module (ELM) for PowerPact H- and J-Frame MCCBs**

The Earth Leakage Module (ELM) is an add-on module which, when connected to a PowerPact H- or J-frame MCCB, provides low-level ground-fault sensing and ground-fault relay functions.

Because these ELMs are highly sensitive (30 mA to 3 A), they provide much greater protection than GFMs (20 Amps to 200 Amps sensitivity). The ELMs provide greater protection of control circuits and other sensitive equipment. The associated circuit breaker must have a 48 Vdc shunt trip, which may be field-installed (kit S29392) or factory-installed (suffix -SP) in the H- or J-Frame circuit breaker.

Add-on Earth Leakage Module (ELM) Features:

- Adjustable ground-fault pickup levels as low as 30 mA
- Adjustable ground-fault time delays from instantaneous to 500 msec (Time delay can be applied to the 30 mA setting)
- Integral ground fault push-to-test feature
- Ground-fault indicator; pop-up button for local status and contacts for remote indication (to be used only with the tripping option)
- All ELMs are supplied for I-Line™ mounting and are easily convertible to unit-mount by removing the I-Line brackets
- Three poles; 240 to 600 Vac maximum: 3-wire applications only (no neutral)
- Line-power obtained through internal bus to provide power for electronics, shunt trip, and integral test feature.
- A shunt trip is required in the circuit breaker; it may be field-installed or factory-installed in the PowerPact H and J circuit breakers.
- UL 1053 – Ground-fault Sensing and Relaying Equipment

**Table 7.145: ELM Selection Chart [5]**

Companion Circuit Breaker [6]	Enclosure Space Required I-Line Switchboard	Pick-Up Adjustment Range	Catalog Number
HD, HG, HJ, HL	LA	30 mA–3 A	ELM150HD
JD, JG, JJ, JL	LA	30 mA–3 A	ELM250JD



I-Line J-Frame with ELM Installed

[3] At 250 A, the GFM250JD can be used with 80% rated circuit breakers only.

[4] See Supplemental Digest Section 3 for additional GFMs.

[5] At 250 A, the ELM250JD can be used with 80% rated circuit breakers only.

[6] For Factory Installation of ELM Module: For termination designation (3rd letter of catalog number) use ONLY "M". Add factory installed 48 Vdc shunt trip (suffix SP) to breaker plus suffix VL or VM.

Miniature and Molded Case Circuit Breaker Dimensions  
Table 7.146: QO™, QOU, Multi 9™ Circuit Breakers

Circuit Breaker Cat. No. Prefix	Poles	Fig. No.	Dimensions—Inches						
			A	B	C	D	E	F	G
QO, QOB	1	1	0.75	3.00 <sup>[1]</sup>	2.31	2.91	2.25	—	0.59
	2	2	1.50	3.00 <sup>[1]</sup>	2.31	2.91	2.25	—	1.34
	3	3	2.25	3.00 <sup>[1]</sup>	2.31	2.91	2.25	—	2.09
QOB-VH 150 A	2	2	3.0	5.72	2.53	4.90	3.78	—	2.85
QOB-VH 110–150 A	3	3	4.50	5.72	2.53	4.90	3.78	—	4.35
QO-PL	1	4	0.75	4.12 <sup>[2]</sup>	2.31	2.91	2.25	—	0.59
QO-GFI	2	5	1.50	4.12 <sup>[2]</sup>	2.31	2.91	2.25	—	1.34
QO-EPD	3	5	2.25	4.12 <sup>[2]</sup>	2.31	2.91	2.25	—	2.09
QOU	1	6	0.75	4.05 <sup>[3]</sup>	2.38	2.98	2.25	5.00 <sup>[4]</sup>	0.62
QYU	2	7	1.50	4.05 <sup>[3]</sup>	2.38	2.98	2.25	5.00 <sup>[4]</sup>	1.37
Low Ampere	3	8	2.25	4.05 <sup>[3]</sup>	2.38	2.98	2.25	5.00 <sup>[5]</sup>	2.12
QOU	1	10	0.75	4.45	2.37	2.96	2.25	6.78	—
High Ampere	2	11	1.50	4.45	2.37	2.96	2.25	6.78	—
	3	12	2.25	4.45	2.37	2.96	2.25	6.78	—
Multi 9™ C60	1	13	0.71	3.19	1.73	2.76	1.77	—	—
	2	14	1.42	3.19	1.73	2.76	1.77	—	—
	3	15	2.13	3.19	1.73	2.76	1.77	—	—
	4	16	2.84	3.19	1.73	2.76	1.77	—	—
QO-PLPS Power Supply	2	9	1.45	4.35	2.42	3.11	—	—	—

Table 7.147: QB, QD, QG, QJ, Q4, FA, LA, Circuit Breakers

Circuit Breaker Cat. No. Prefix	Poles	Fig. No.	Dimensions—Inches							
			A	B	C	D	E	F	G	H
QB, QD, QG, QJ	2	22	6.47	3.00	3.02	3.93	6 <sup>[6]</sup>	4.25	—	—
	3	23	6.47	4.50	3.02	3.93	6 <sup>[6]</sup>	4.25	1.50	0.75
	1	21	6.00	1.50	3.16	4.13	0.44	5.13	1.50	—
FAL, FHL	2	22	6.00	3.00	3.16	4.13	0.44	5.13	—	—
	3	23	6.00	4.50	3.16	4.13	0.44	5.13	1.50	0.75
Q4L, LAL, LHL	2 & 3	23	11.00	6.00	4.06	5.84	0.88	9.25	2.00	1.00

Table 7.148: Shipping Weights<sup>[7]</sup>

Frame Size	Approx. Shipping Weight (Lbs.)	Frame Size	Approx. Shipping Weight (Lbs.)
FAL, FHL 1P	2	QB, QD, QG, QJ	4
FAL, FHL 2P	3	LAL, LHL	15
FAL, FHL 3P	5	Q4L	15

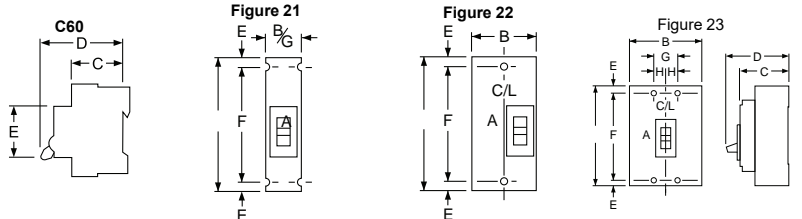
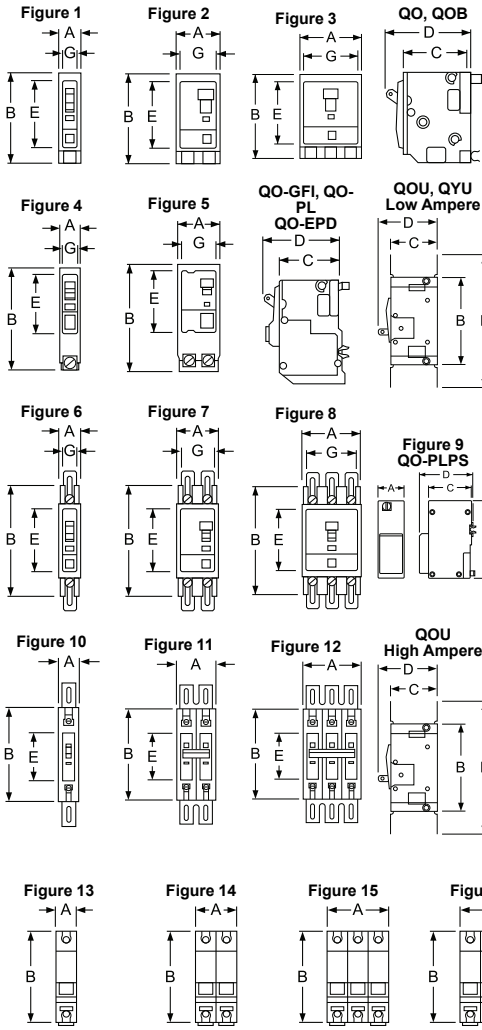

[1] 35–70 A is 3.12 in; 80–100 A 2P and 70–100 A 3P are 3.50 in.  
 [2] QO-PL is 4.55 in.  
 [3] 80–100 A 1P and 80–125 A 2P are 4.45 in.  
 [4] 80–100 A 1P and 80–125 A 2P are 6.78 in.  
 [5] 70–100 A is 6.78 in.  
 [6] Dimensions E are 1.59 in at ON end and 0.63 in at OFF end.  
 [7] All weights are for 3P circuit breakers unless otherwise noted.

**Molded Case Circuit Breaker Dimensions**

**Table 7.149: PowerPact B-, H-, J-, and L-Frame Circuit Breakers**

Circuit Breaker Frame	No. of Poles	Fig. No.	Dimensions — Inches							
			A	B	C	D	E	F	G	H
B-Frame	1	35	6.79	1.06	3.15	4.01	0.20	6.33	—	5.39
	2	36	6.22	2.12	3.15	4.01	0.86	4.48	—	5.39
	3	37	6.22	3.19	3.15	4.01	0.86	4.48	1.06	5.39
	4	38	6.22	4.25	3.15	4.01	0.86	4.48	2.12	5.39
H-Frame	2 [8]	25	6.40	2.74	2.87	4.36	0.74	4.92	—	—
	3	26	6.40	4.12	2.87	4.36	0.74	4.92	1.38	—
J-Frame	3	27	7.52	4.12	2.87	5.00	1.30	4.92	1.38	—
L-Frame	3	28	13.38	5.51	3.75	6.61	2.22	7.87	1.77	—

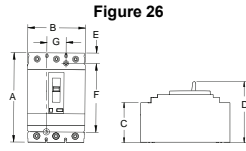
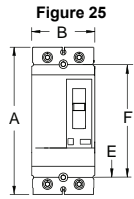

**Figure 27**

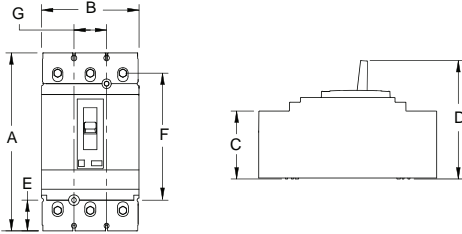

**Figure 28**

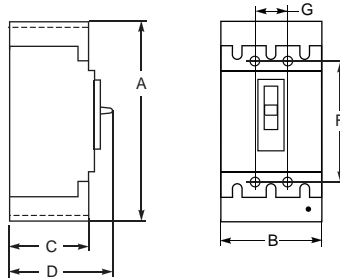

**Figure 29**

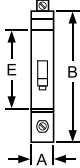

**Figure 30**

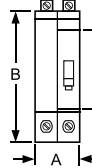

**Figure 31**

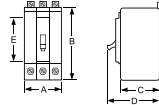

**Figure 32**

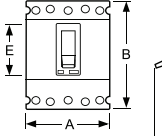

**Figure 33**

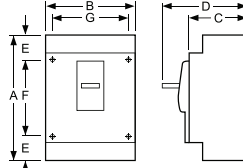

**Figure 34**

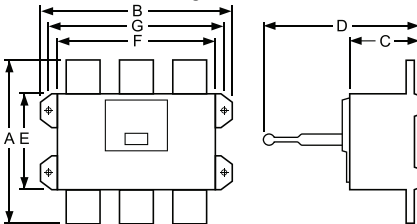

**Table 7.150: ED, EG, EJ, and GJ Circuit Breakers**

Circuit Breaker Cat. No. Prefix	No. of Poles	Fig. No.	Dimensions — Inches				
			A	B	C	D	E
ED, EG, EJ	1	29	0.98	5.66	3.09	4.05	3.32
ED, EG, EJ	2	30	1.96	5.66	3.09	4.05	3.32
ED, EG, EJ	3	31	2.94	5.66	3.09	4.05	3.32
GJ	3	32	3.54	4.72	2.76	3.94	2.20

**Table 7.151: PowerPact M-, P-, and R-Frame Circuit Breakers**

Circuit Breaker Frame	No. of Poles	Fig. No.	Dimensions — Inches						
			A	B	C	D	E	F	G
M-Frame (800 A and below)	2, 3	33	12.86	8.27	5.77	8.05	2.49	7.87	7.83
P-Frame (1000–1200 A)	2, 3	33	16.16	8.27	5.77	8.05	4.19	7.87	7.83
R-Frame	2, 3	34	16.24	16.54	6.63	14.49	8.73	14.25	15.35

**Table 7.152: Shipping Weights [9]**

Frame Size	Approx. Shipping Weight (Lbs.)	Frame Size	Approx. Shipping Weight (Lbs.)
B-Frame 1P	1	H-Frame 2P	4
B-Frame 2P	2	H-Frame 3P	5
B-Frame 3P	3	J-Frame	5
B-Frame 4P	4	L-Frame	14
EDB 1P	2	M-Frame	29
EDB 2P	3	P-Frame	32
EDB 3P	4	R-Frame (Without RLTB)	52

**Figure 35**

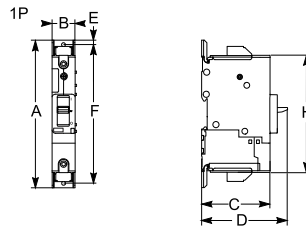

**Figure 36**

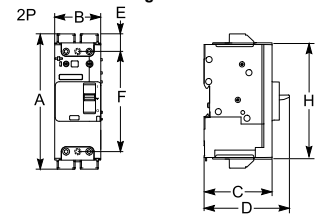

**Figure 37**

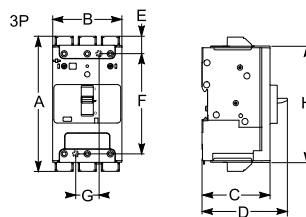

**Figure 38**

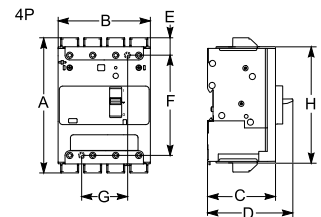

[8] Only HD and HG are in 2P module, HJ, HL and HR 2P are in 3P module.  
[9] All weights are for 3P circuit breakers unless otherwise noted.

## Circuit Breaker Enclosures

### F- and L-Frame Thermal-Magnetic Circuit Breaker Enclosures

The enclosures for the F- and L-Frame thermal-magnetic circuit breakers are UL listed and CSA certified. The enclosures are suitable for service entrance equipment when neutral assembly is installed. The short circuit ratings of these enclosed circuit breakers are equal to the interrupter rating, at the supply voltage marked on the circuit breaker installed.

#### F-Frame Thermal-Magnetic Circuit Breaker Enclosures

The FA100RB enclosure has a provision of 3/4 through 2 1/2 inch B-Type bolt-on hubs in the top end wall. For details and hub catalog numbers see page 3-10.



FA100S



FA100RB



FA100DS

**Table 7.153: F-Frame Thermal-Magnetic Circuit Breaker Enclosures**

Circuit Breaker			Cat. No.				
Cat. No. Prefix	Rating	Poles	Enclosure			Neutral Assembly Kit	Service Ground Kit
			NEMA 1 Flush	NEMA 1 Surface	NEMA 3R		
FAL, FHL, FCL	15–100 A	1, 2, 3	FA100F	FA100S	FA100RB	SN100FA	PKOGTA2
			NEMA 4, 4X, 5 [1] Type 304 Stainless Steel [2]	NEMA 12K With Knockouts	NEMA 12/3R Without Knockouts [2]		
FAL, FHL, FCL	15–100 A	1, 2, 3	FA100DS	FA100A	FA100AWK	SN100FA	PKOGTA2

#### L-Frame Thermal-Magnetic Circuit Breaker Enclosures

The LA400R enclosure has a blank top end wall and requires field cut openings. For details and hub catalog numbers see page 3-10.

**Table 7.154: L-Frame Thermal-Magnetic Circuit Breaker Enclosures**

Circuit Breaker			Enclosure			Neutral Assembly Kit	Service Ground Kit
Cat. No. Prefix	Rating	Poles	Cat. No.	Cat. No.	Cat. No.	Cat. No.	Cat. No.
			NEMA 1 Flush	NEMA 1 Surface	NEMA 3R		
LAL, LHL, Q4L	125–225 A 225–400 A	2, 3	LA400F[3]	LA400S[3]	LA400R	SN225KA 400SN	PKOGTA2
LAL	125–400	3	—	LA400LS [4] [5][6][7]	—	SN400LA	
			NEMA 4, 4X, 5 [1] Type 304 Stainless Steel [2]	NEMA 12K With Knockouts	NEMA 12/3R Without Knockouts [2]		
LAL, LHL, Q4L	125–225 A 225–400 A	2, 3	LA400DS[6]	—	LA400AWK[6]	SN225KA SN400LA	PKOGTA2

[1] Complete rating is NEMA 3, 3R, 4, 4X, 5, and 12.  
 [2] For NEMA 3R applications, remove drain screw from bottom endwall.  
 [3] Enclosures are provided with the Handle Padlock Attachment (HPALM) for field installation to lock the circuit breaker in the "ON" or "OFF" positions.  
 [4] Use copper conductors only.  
 [5] Maximum short circuit and voltage is 30 kAIR at 480 Vac.  
 [6] LAL or LHL circuit breakers with an MB or MT suffix are not compatible with these enclosures: LA400DS, LA400AWK, and LA400LS.  
 [7] Enclosure cover has an integral padlock provision to provide a means to lock the circuit breaker in the "ON" or "OFF" position.

**PowerPact Circuit Breaker Enclosures**

The enclosures for the family of PowerPact circuit breakers H- through Q-frame are cULus listed unless otherwise noted. The enclosures are suitable for service entrance equipment when neutral assembly is installed. The short circuit current rating of the enclosed circuit breakers is equal to the rating of the circuit breaker installed unless otherwise noted. All enclosures will accept 100% rated circuit breakers unless otherwise noted.

**PowerPact H- and J-Frame Circuit Breaker Enclosures**

The enclosures' maximum short circuit ratings are 25 kAIR at 600 Vac, 65 kAIR at 480 Vac, 125 kAIR at 240 Vac and 20 kA at 250 Vdc unless otherwise noted. Enclosures accept 100% rated circuit breakers [8]. The enclosures are not compatible with earth-leakage or ground-fault modules.

**Table 7.155: PowerPact H- and J-Frame Circuit Breaker Enclosures**

Circuit Breaker			Enclosure Cat. No.			Neutral Assembly Kit	Service Ground Kit
Cat. No. Prefix	Rating	Poles	NEMA 1 Flush	NEMA 1 Surface	NEMA 3R	Cat. No.	Cat. No.
HDL	15–100 A	3	—	HD100S [9][10][11]	—	SN100FA	PKOGTA2
HDL, JDL	125–225 A	3	—	JD250S [12][10][11]	—	SN225KA	PKOGTA2
	125–250 A					SN400LA	
HDL, HGL	15–100 A	2	H150F	H150S	H150R [13]	SN100FA	PKOGTH150
	125–150 A					SN400LA	
HJL, HLL	15–100 A	2	J250F	J250S [14]	J250R [13][15]	SN100FA	PKOGTH150
HDL, HGL, HJL, HLL	15–100 A	3				SN400LA [16]	
	125–150 A	3					
JDL, JGL, JLL, JLL	150–250 A	2, 3					
			NEMA 4, 4X, 5 [17] Type 304 Stainless Steel [18]	NEMA 4, 4x, 5 [17] Type 316 Stainless Steel [18]	NEMA 12/3R Without Knockouts [18]		
HDL, HGL, HJL, HLL	15–100 A	2, 3	J250DS [19]	J250SS [19]	J250AWK [19]	SN100FA	PKOGTH150
	125–150 A	2, 3				SN400LA [16]	
JDL, JGL, JLL, JLL	150–250 A	2, 3					

**PowerPact L-Frame Circuit Breaker and Molded Case Switch Enclosures**

All enclosures accept 80% rated circuit breakers. The enclosures will also accept 100% rated circuit breakers to 400 amps. The enclosures have a blank top end wall and require field-cut openings. For details and hub catalog numbers see page 3–10.

**Table 7.156: PowerPact L-Frame Circuit Breaker Enclosures**

Circuit Breaker			Cat. No.			
Cat. No. Prefix	Rating	Poles	NEMA 12/3R Enclosures Without Knockouts	Neutral Assembly Kit	Copper Only Neutral Assembly Kit	Service Ground Kit
LDL, LGL, LJL, LLL, LRL	250–400 A	3	L600AWK [20][18][19]	SN400LA	SNC400LX	PKOGTA4
	400–600 A			SN1000MA	SNC800LX	
LGL, LLL, LRL	250–400 A	3	L600AWKMC [21][18]	SN400LA	SNC400LX	PKOGTA4
	400–600 A			SN1000MA	SNC800LX	

**PowerPact Q-Frame Circuit Breaker Enclosures**

The enclosures for the PowerPact Q Frame Circuit Breaker are UL listed. The short circuit ratings of these enclosed circuit breakers are equal to the interrupter ratings, at the supply voltage marked on the circuit breaker installed, unless otherwise noted.

**Table 7.157: PowerPact Q-Frame Circuit Breaker Enclosures**

Circuit Breaker			Enclosure Cat. No.			Neutral Assembly Kit	Service Ground Kit
Cat. No. Prefix	Rating	Poles	NEMA 1 Flush	NEMA 1 Surface	NEMA 3R	Cat. No.	Cat. No.
QBL, QDL, QGL, QJL [22]	70–225 A	2	—	Q22200NS [23]	Q22200NRB [23]	—	PKOGTA2
		2, 3	Q23225NF	Q23225NS	Q23225NRB		

[8] Use only 90°C (minimum) rated wire sized per ampacity of 75°C rated conductors for 100% rated circuit breakers.

[9] Rated for 240 Vac maximum. Short circuit current rating is 25 kAIR at 240 Vac.

[10] Accepts standard 80% rated circuit breakers only. Not rated for 100% rated circuit breakers.

[11] Use copper conductors only.

[12] Rated 480 Vac maximum. Short circuit current rating is 18 kAIR at 480 V.

[13] For conduit entry through the top end wall use one of the following Square D conduit hubs: A200L for 2.00 in., A250L for 2.50 in., A300L for 3.00 in., A350L for 3.50 in. or A400L for 4.00 in.

[14] Add suffix BE if no knockouts are required on the end walls.

[15] For access to the circuit breaker's standard, ammeter or energy trip unit panel/LCD, add suffix T.

[16] For 200% neutral use copper wire only.

[17] Complete rating is NEMA 3, 3R, 4, 4X, 5, and 12.

[18] For NEMA 3R applications, remove drain screw from bottom endwall.

[19] Add suffix VW for visibility to the standard, ammeter or energy trip unit of the PowerPact circuit breaker.

[20] Will accept PowerPact L-frame circuit breakers and Motor Protectors with suffixes M38X

[21] Will accept PowerPact L-frame Molded Case Switches.

[22] When the QJL circuit breaker is installed in the enclosure, the enclosure is limited to Short Circuit Current ratings of 65 kAIR at 240 V and 100 kAIR at 208 V.

[23] Limited to 200 A.

**PowerPact M- and P-Frame Circuit Breaker Enclosures**

All enclosures will accept 80% rated circuit breakers. The P1200 enclosures will accept 100% rated circuit breakers to 800 A. If a CT neutral is required, the enclosure will no longer accept a 200% neutral. The M800R and the P1200R enclosures have a blank top end wall and require field-cut openings. For details and hub catalog numbers see page 3-10.

**Table 7.158: PowerPact M- and P-Frame Circuit Breaker Enclosures**

Circuit Breaker			Cat. No.						
Cat. No. Prefix	Rating	Poles	Enclosure			Neutral Assembly Kit	200% Neutral Kit	CT Neutral Kit [24][25]	Service Ground Kit
			NEMA 1 Flush	NEMA 1 Surface	NEMA 3R				
MGL, MJL, PGL, P JL, PKL, PLL	300–800 A	2, 3	—	M800S	M800R	AL800SN	SN800SNI and 2 each SN1200	S33576MK	PKOGTA4
PGL, P JL, PKL, PLL	250–1200 A	2, 3	—	P1200S	P1200R	SN1200	—	S33576MK	PKOGTA4
			NEMA 4, 4X, 5 [26] Type 304 Stainless Steel [27]	NEMA 4, 4X, 5 [26] Type 316 Stainless Steel [27]	NEMA 12/3R Without Knockouts [27]				
MGL, MJL, PGL, P JL, PKL, PLL	300–800 A	2, 3	M800DS	M800SS	M800AWK	AL800SN	—	S33576MK	PKOGTA4
PGL, P JL, PKL, PLL	250–1200 A	2, 3	—	—	P1200AWK	SN1200	—	S33576MK	PKOGTA4

**PowerPact L-Frame 500 Vdc Circuit Breaker Enclosures**

The PowerPact L-frame circuit breaker enclosure's maximum short circuit rating is 20 kAIR at 250 Vdc and 50 kAIR at 500 Vdc.

Listed for use ONLY on UPS systems.

**Table 7.159: DC Circuit Breaker Enclosures for LG and LL DC-Rated Circuit Breakers**

Circuit Breaker [28]			NEMA 1 Surface Enclosure	Replacement Ground Lugs	Service Ground Kit
Cat. No. Prefix	Ampere Rating	Poles	Cat. No.	Cat. No.	Cat. No.
LGL, LLL	300–600 A	3	L1200S	8010440301	Standard
	700–1200 A	4	L1200S		

[24] Order current transformer kit S33576 separately.

[25] Current transformers applicable only on PowerPact P circuit breakers. Current limitations are 400–800 A and 400–1200 A respectively for the M800 and P1200 family of enclosures.

[26] Complete rating is NEMA 3, 3R, 4, 4X, 5, and 12.

[27] For NEMA 3R applications, remove drain screw from bottom endwall.

[28] Use 500 Vdc or 250 Vdc rated circuit breakers only.

## Enclosures for Special Applications

### Hazardous Locations: NEMA 7 And NEMA 9 Circuit Breaker Enclosures

The NEMA 7 and 9 enclosures are cULus listed unless otherwise noted. They are rated for use in hazardous locations as defined in NEC Article 500. The short circuit current rating of the enclosed circuit breakers is equal to the rating of the circuit breaker installed unless otherwise noted. They are suitable for use as service entrance equipment when neutral is installed. Enclosures require the use of 75°C copper wire only. The NEMA 7 enclosures are suitable for rainproof applications when the included PKDB1 breather and drain kit is installed.

**Table 7.160: NEMA 7 and NEMA 9 Circuit Breaker Enclosures; Thermal-Magnetic F-Frame and PowerPact J-Frame Circuit Breakers**

Circuit Breaker			Enclosure Catalog Number		Neutral Assembly Kit Cat. No.	Service Ground Kit Cat. No.	Threaded Conduit Provisions, Inches
Cat. No. Prefix	Rating	Poles	NEMA 7 Cast Aluminum [29]	NEMA 9 Cast Aluminum [30]			
FAL, FHL	15–60 A	1, 2, 3	FA060X	FA060Y	100SNA	Included	3/4 in.
FAL, FHL	15–100 A	1, 2, 3	FA100X	FA100Y	100SNA	Included	1 1/4 in.
JDL, JGL	150–225 A	2, 3	J225X [31][32]	J225Y [31][32]	225SNA	Included	2 1/2 in.

### Enclosures for Walking Beam Circuit Breakers

**Table 7.161: Enclosures for Walking Beam Manually Operated Mechanical Interlock Circuit Breakers (UL Listed) [33]**

Circuit Breaker			NEMA 1 Surface Enclosure Cat. No. [34]	NEMA 3R Enclosure Cat. No. [34][35]
Cat. No. Prefix...Suffix	Ampere Rating	Poles		
FAL...WB, FHL...WB	15–100 A	2, 3	KA250SWB	KA250RWB

### Enclosed Motor-Operated Molded Case Circuit Breakers

For information on Enclosed Motor-Operated Molded Case Circuit Breakers see Supplemental Digest Section 3.

### Enclosed Molded Case Switches

For information on enclosed molded case switches, see Supplemental Digest Section 3.

[29] NEMA 7 — Indoor Hazardous Locations — Division 1 and 2, Class I, Groups C and D; Class II, Groups E, F and G; Class III

[30] NEMA 9 — Indoor Hazardous Locations — Division 1 and 2, Class ii, Groups E, F and G; Class iii

[31] Short circuit current rating: 65 kAIR at 240 Vac, 25 kAIR at 480 Vac, and 18 kAIR at 600 Vac

[32] Not cULus listed due to wire bending space.

[33] Catalog number in table is enclosure only. For complete installation, the following must be ordered separately: WB Circuit Breakers (qty. 2, Supplemental Digest Section 3), Walking Beam Assembly (Supplemental Digest Section 3), Mounting Pan (Supplemental Digest Section 3) and Neutral and Service Ground Kits, below

[34] Enclosure has blank top endwall.

[35] For applications above 200 A requiring a neutral, use copper wire only.

## Enclosure Accessories

Table 7.162: Neutral Kit Terminal Data

Neutral Kit Catalog Number	Terminal Lug Data -Total Available (Line plus Load) AWG/kcmil AL/CU	All Copper Neutral Terminal Lug Data -Total Available (Line plus Load) AWG/kcmil
100SNA	(2) 14-1/0 Cu or (2) 12-1/0 Al plus (1) 14-4 Cu	—
SN100FA	(4) 14-1/0 Cu or (4) 12-1/0 Al	—
SN225KA	(2) 4-300 Al/Cu plus (2) 14-1/0 Al/Cu	—
225SNA	(4) 6-350 Al/Cu	—
400SN	(2) 1-600 or (4) 1-250 Al/Cu, plus (2) 4-300 Al/Cu	—
SN400LA	(2) 1-600 or (4) 1-250 Al/Cu, plus (2) 4-300 Al/Cu	—
SN1000MA	(6) 3/0-500 Al/Cu, plus (1) 1-4/0 Al/Cu	—
SNC400LX	—	(2) 2-600 Cu, plus (2) 6-250 Cu
SNC800LX	—	(4) 2-600 Cu, plus (1) 2-4/0 Cu
AL800SN	(6) 3/0-500 Al/Cu, plus (2) 6-250 Al/Cu	—
SN1200	(8) 3/0-750 Al/Cu, plus (2) 6-350 Al/Cu	—
S33576MK	(8) 3/0-500 Al/Cu, plus (2) 4-300 Al/Cu	—

Table 7.163: Service Ground Kit Terminal Data

Service Ground Kit Catalog Number	Terminal Data AWG/kcmil	Lugs Per Kit
PKOGTA2	10-2/0 Cu or 6-2/0 Al	2
PKOGTH150	14-2 Al/Cu	2
PKOGTJ250	6-300 Al/Cu	2
PKOGTA4	6-250 Al/Cu	4

See Supplemental Digest Section 3 for special options for enclosures:

- Stainless steel fronts
- Pilot lights, push buttons
- Lock-on SPL0
- Key interlock systems
- Legend plates

**Enclosure Dimensions**

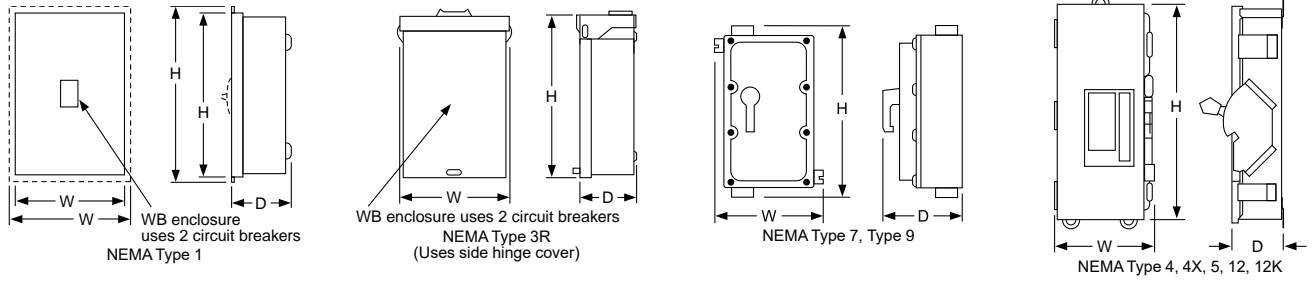

**Table 7.164: Dimensions**

Cat. No.	Series	Approximate Dimension					
		H		W		D	
		in.	mm	in.	mm	in.	mm
FA100A, AWK	E05	19.50	495	9.13	232	4.88	124
FA100DS	E05	19.50	495	9.13	232	4.88	124
FA100F	E2	19.50	495	9.88	251	4.13	105
FA100RB	E2	18.00	457	8.88	226	4.88	124
FA100S	E2	18.13	461	8.63	219	4.13	105
FA060X	E1	16.00	406	9.88	251	7.00	178
FA060Y	E1	16.00	406	9.88	251	7.00	178
FA100X	E1	16.00	406	9.88	251	7.00	178
FA100Y	E1	16.00	406	9.88	251	7.00	178
HD100S	A01	17.00	431.8	7.90	200.7	4.75	120.7
H150F	A01	32.40	823	15.40	391	6.00	152
H150R	A01	31.05	789	14.47	368	6.28	160
H150S	A01	31.36	797	14.36	365	6.00	152
J250F	A01	32.40	823	15.40	391	6.00	152
J250R	A01	31.05	789	14.47	368	6.28	160
J250S	A01	31.36	797	14.36	365	6.00	152
J250DS	A01	32.26	819	9.72	247	7.94	202
J250SS	A01	32.26	819	9.72	247	7.94	202
J250AWK	A01	32.26	819	9.72	247	7.94	202
JD250S	A01	26.40	670.6	8.90	226.1	5.50	139.7
J225X	A01	22.70	577	10.93	278	7.70	196
J225Y	A01	22.70	577	10.93	278	7.70	196
KA250SWB	E2	20.00	508	19.00	483	5.63	143
KA250RWB	E2	20.25	514	19.00	483	7.12	181
L600AWK	A01	57.50	1461	20.38	518	8.25	210
L600AWKVW	A01	57.50	1461	20.38	518	8.25	210
L600AWKMC	A01	57.50	1461	20.38	518	8.25	210
L1200S	A01	51.88	1818	20.25	514	7.75	197
LA400AWK	E05	42.25	1073	13.75	349	7.25	184
LA400DS	E05	42.25	1073	13.75	349	7.25	184
LA400F	E03	45.63	1159	16.50	419	6.50	165
LA400R	E03	44.00	1118	15.38	391	7.88	200
LA400S	E03	44.50	1130	15.38	391	6.50	165
LA400LS	A01	27.40	696.0	15.40	391.2	6.625	168.3
M800S	A01	40-3/8	1025.52	21	533.4	9-3/4	247.65
M800R	A01	40-3/8	1025.52	21	533.4	9-3/4	247.65
M800DS	A01	40-7/8	1036.96	20-3/4	527.05	9-1/2	241.3
M800SS	A01	40-7/8	1036.96	20-3/4	527.05	9-1/2	241.3
M800AWK	A01	40-7/8	1036.96	20-3/4	527.05	9-1/2	241.3
P1200S	A01	52-1/8	1323.98	21	533.4	9-3/4	247.65
P1200R	A01	52-1/8	1323.98	21	533.4	9-3/4	247.65
P1200AWK	A01	53	1346.20	20-3/4	527.05	9-1/2	241.3
Q22200NRB	E05	23.38	594	7.63	194	4.75	121
Q22200NS	E05	23.13	588	7.63	194	4.25	108
Q23225NF	E05	26.25	667	9.88	251	4.75	121
Q23225NRB	E05	26.25	667	9.88	251	5.50	140
Q23225NS	E05	26.25	667	9.88	251	4.75	121

