

TOP VIEW

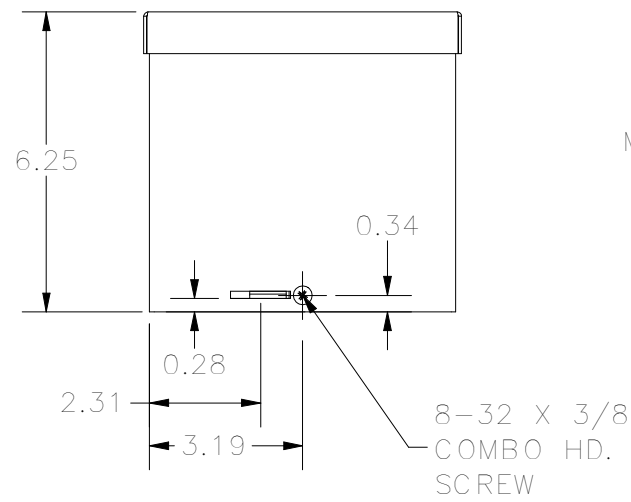

FRONT VIEW

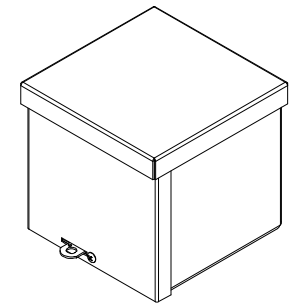
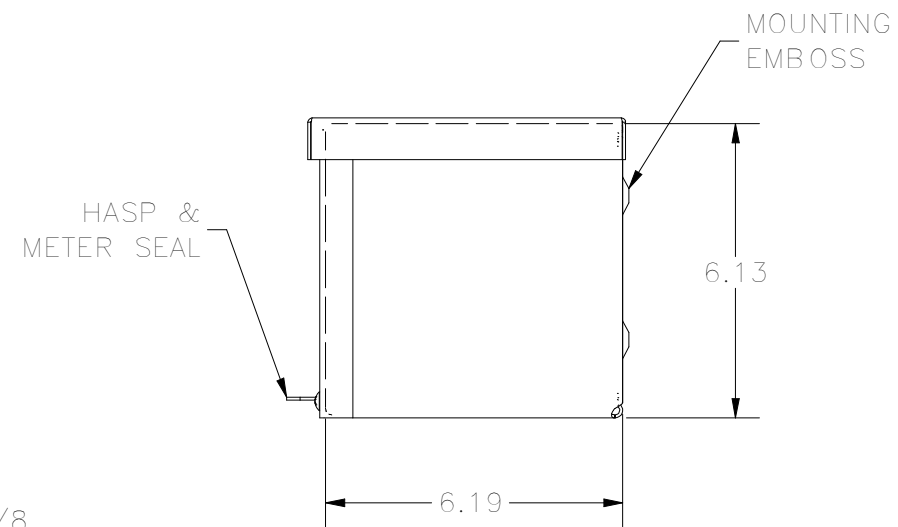

RIGHT VIEW

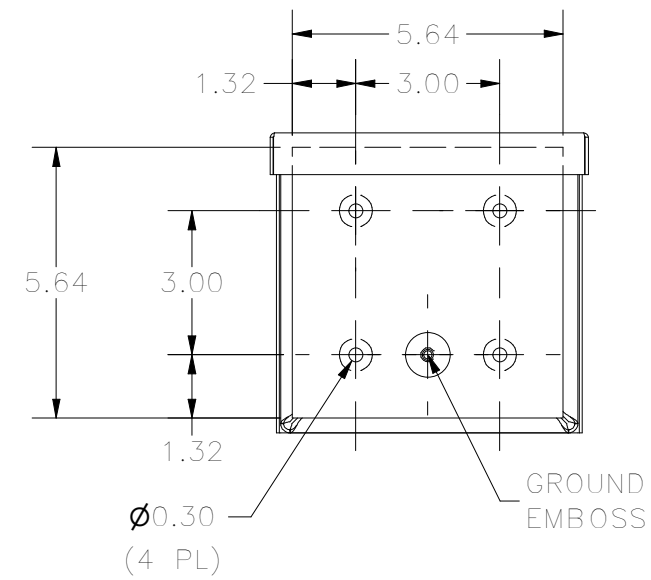

BACK VIEW

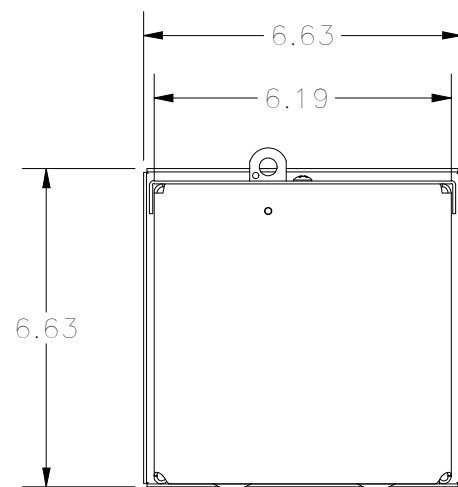

BOTTOM VIEW

PART #:060606NK
(DATA SUBJECT TO CHANGE WITHOUT NOTICE)
THIS DRAWING IS THE PROPERTY OF HUBBELL INC. WIEGMANN
ALL INFORMATION IS PROPRIETARY AND NOT TO BE DUPLICATED